

Testing Packet Time and Frequency

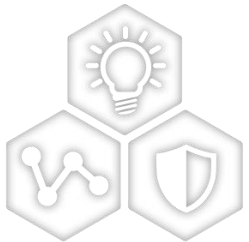

A Leading Provider of Smart, Connected and Secure Embedded Control Solutions



SMART | CONNECTED | SECURE

Lee Cosart
May 2022

Introduction

- **Frequency Transport**

- One-way: forward and reverse packet streams can be used separately
- Asymmetry is irrelevant
- Stable frequency needed
- PRC (primary reference clock) needed
- GNSS/GPS antenna cable compensation/calibration not needed
- GSM frequency backhaul (50 ppb) is example technology

- **Time Transport**

- Two-way: forward and reverse packet streams used together
- Asymmetry is critical
- Stable time and frequency needed
- PRTC (primary reference time clock) or ePRTC (enhanced PRTC) needed
- GNSS/GPS antenna cable compensation/calibration needed
- LTE-TDD and 5G time/phase (1.5 μ sec) are example technologies

Testing Frequency “Physical” vs. “Packet”

- **“TIE” (Single Point Measurement)** Measurements are made at a single point – a single piece of equipment in a single location – a phase detector with reference – is needed

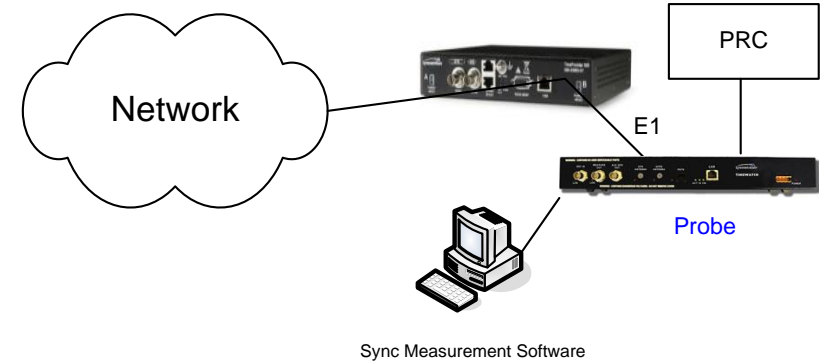
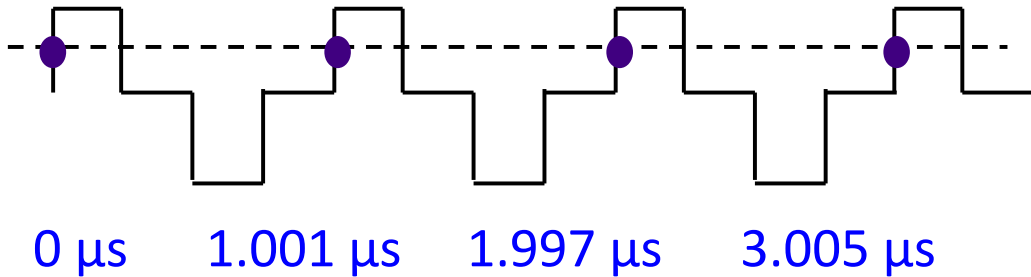

- **“PDV” (Dual Point Measurement)** Measurements are constructed from packets time-stamped at two points – in general two pieces of equipment, each with a reference, at two different locations – are needed

	Timestamp A	Timestamp B
F	1233166476.991204496	1233166476.991389744
R	1233166476.980521740	1233166476.980352932
F	1233166477.006829496	1233166477.007014512
R	1233166476.996147084	1233166476.995977932
F	1233166477.022454496	1233166477.022639568
R	1233166477.011771820	1233166477.011602932

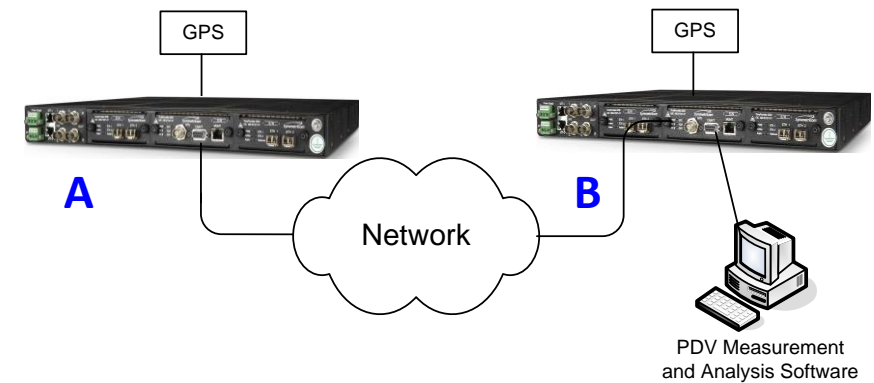

Testing Time “Physical” vs. “Packet”

- **“1 PPS” (Single Point Measurement)** Measurements are made at a single point – a single piece of equipment in a single location – a phase detector with reference – is needed

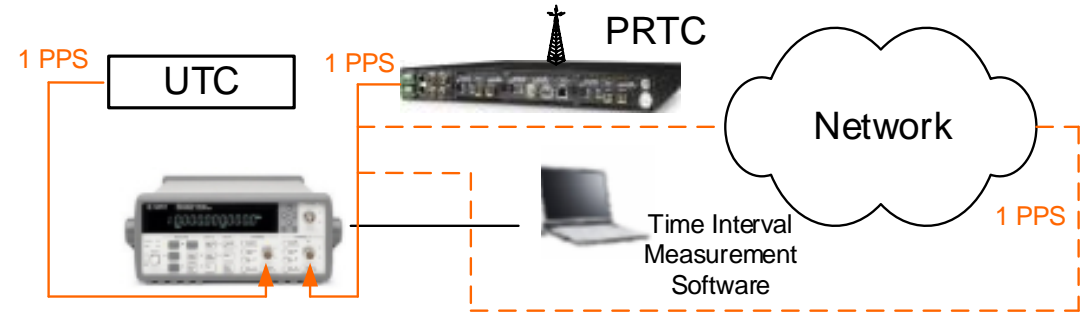
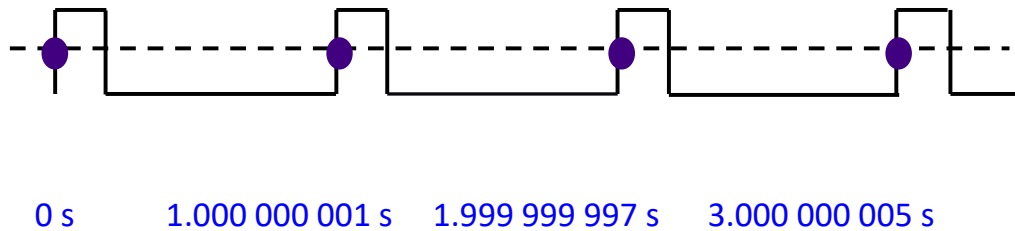

- **“Packet” (Dual Point Measurement)** Measurements are constructed from packets time-stamped at two points – in general two pieces of equipment, each with a reference, at two different locations – are needed

Timestamp A

Timestamp B

F	1286231440.883338640	1286231440.883338796
R	1286231441.506929352	1286231441.506929500
F	1286231441.883338640	1286231441.883338796
R	1286231442.506929352	1286231442.506929500
F	1286231442.883338640	1286231442.883338796
R	1286231443.506929352	1286231443.506929516

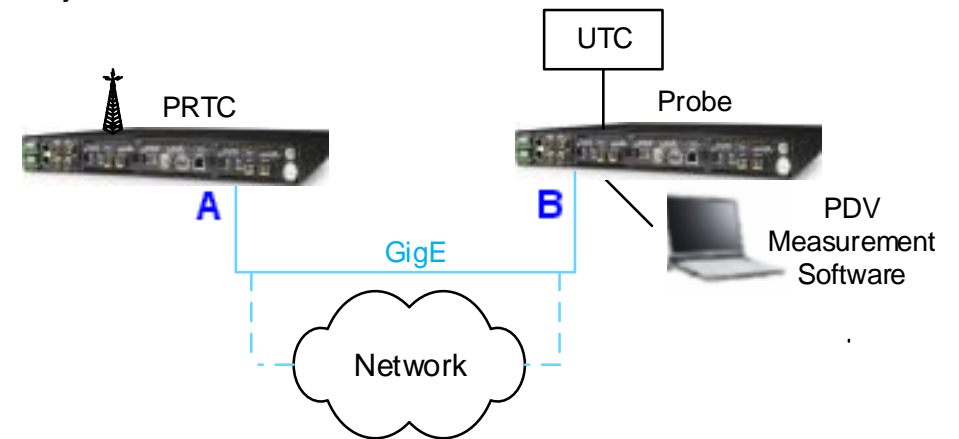

Grandmaster Test PPS and Packet Probe

Physical 1 PPS signal measurement and
packet signal tested with probe match

Phase deviation in units of time; $F_s=499.8$ mHz; $F_o=1.0000000$ Hz

1 (blue): HP 53132A; Test: 4474; 1588 Master; 1PPS; 2 (red): TP5000 Probe;

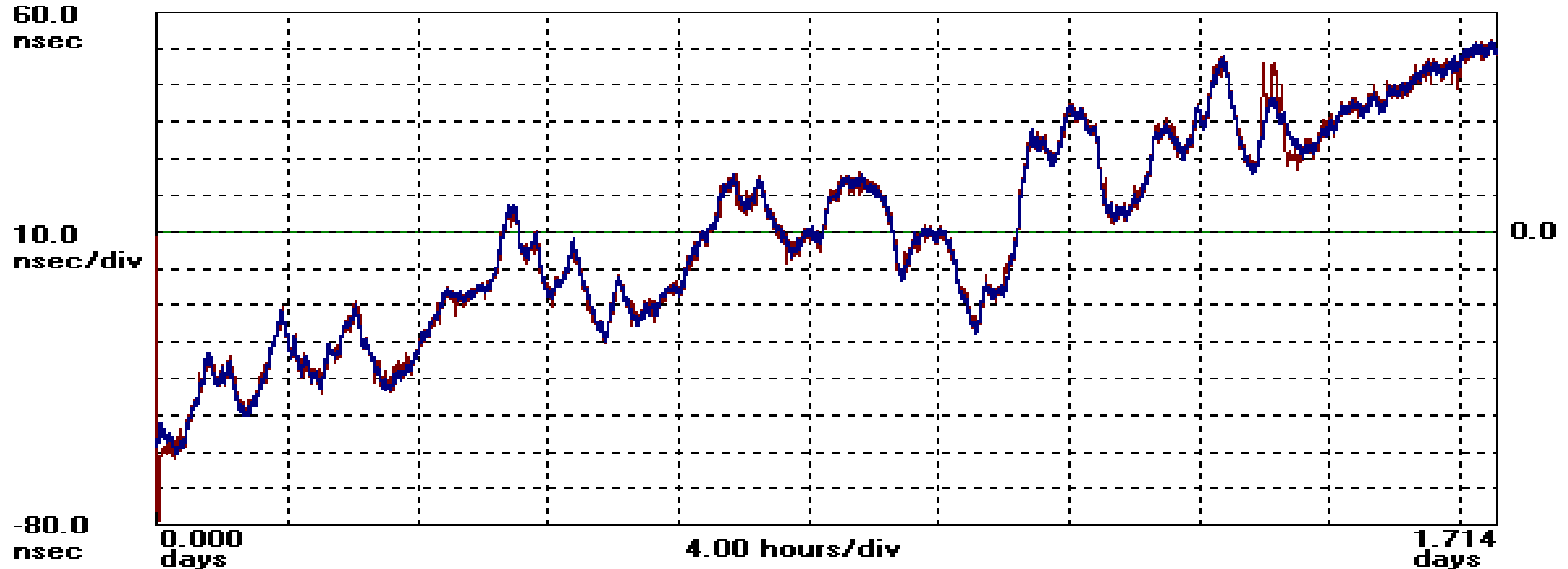

“TIE” Analysis vs. “PDV” Analysis

“TIE” Analysis (G.810)

- Phase (TIE)
- Frequency accuracy
- Dynamic frequency
- MTIE
- TDEV

“PDV” Analysis (G.8260)

- Phase (PDV)
 - Histogram/PDF*, CDF**, statistics
 - Dynamic statistics
 - MATIE/MAFE
 - TDEV/minTDEV/bandTDEV
- * PDF = probability density function
** CDF = cumulative distribution function

- ▶ The importance of raw TIE/PDV:
 - Basis for frequency/statistical/MTIE/TDEV analysis
 - Timeline (degraded performance during times of high traffic?)
 - Measurement verification (jumps? offsets?)

Stability Metrics

- **Traditional Clock Metrics**

- ADEV, TDEV, MTIE
- Traditionally applied to oscillators, synchronization interfaces
- Also applied to lab packet equipment measurements

GM, BC

- **Frequency Transport Packet Metrics**

- minTDEV, MAFE, MATIE
- Applied to one-way packet delay data
- FPP/FPR/FPC (floor packet percentage/rate/count)

- **Time Transport Packet Metrics**

- pktselected2wayTE
- Applied to two-way packet delay data
- Assesses link asymmetry

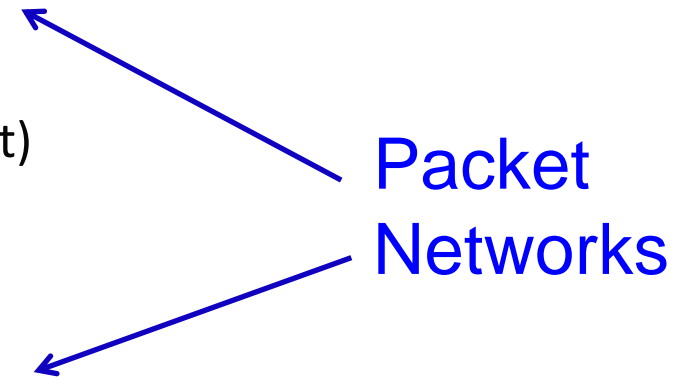

Stability Metrics for PDV

- **Packet Selection Processes**

- 1) **Pre-processed:** packet selection step prior to calculation. Example: **TDEV** (*PDVmin*) where *PDVmin* is a new sequence based on minimum searches on the original PDV sequence
- 2) **Integrated:** packet selection integrated into calculation. Example: **minTDEV** (*PDV*)

- **Packet Selection Methods**

- Minimum: $x_{\min}(i) = \min [x_j] \text{ for } (i \leq j \leq i + n - 1)$

- Percentile: $x'_{pct_mean}(i) = \frac{1}{m} \sum_{j=0}^b x'_{j+i}$

- Band: $x'_{band_mean}(i) = \frac{1}{m} \sum_{j=a}^b x'_{j+i}$

- Cluster:
$$x(n\tau_0) = \frac{\sum_{i=0}^{(K-1)} w((nK+i)\tau_p) \cdot \phi(n,i)}{\sum_{i=0}^{(K-1)} \phi(n,i)} \quad \phi(n,i) = \begin{cases} 1 & \text{for } |w(nK+i) - \alpha(n)| < \delta \\ 0 & \text{otherwise} \end{cases}$$

Packet Selection Windows

- **Windows**

- **Non-overlapping windows** (next window starts at prior window stop)
- **Skip-overlapping windows** (windows overlap but starting points skip over N samples)
- **Overlapping windows** (windows slide sample by sample)

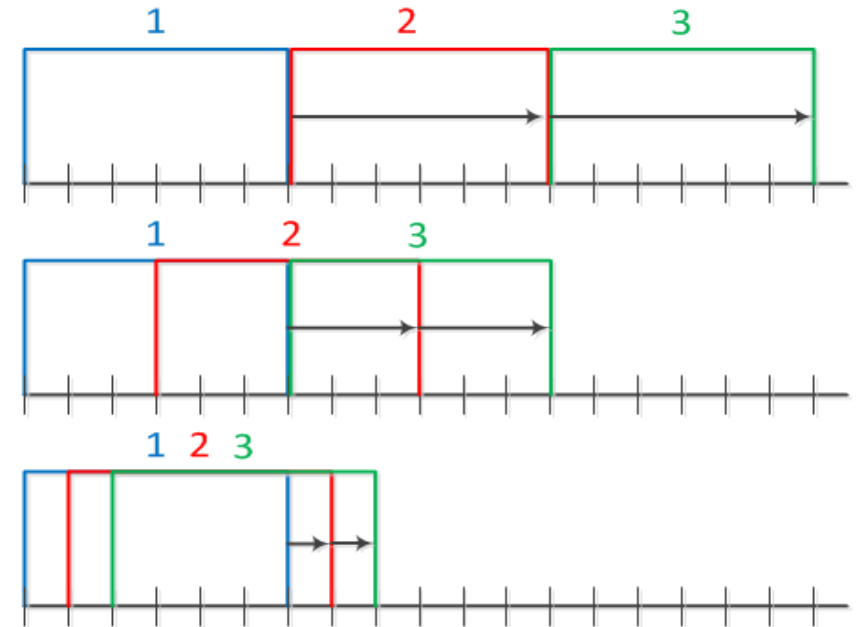

- **Packet Selection Approaches**

- Select X% fastest packets (e.g. 2%)
- Select N fastest packets (e.g. 10 fastest packets in a window)
- Select all packets faster than Y (e.g. all packets faster than 150 μ s)

G.8260 Appendix I Metrics

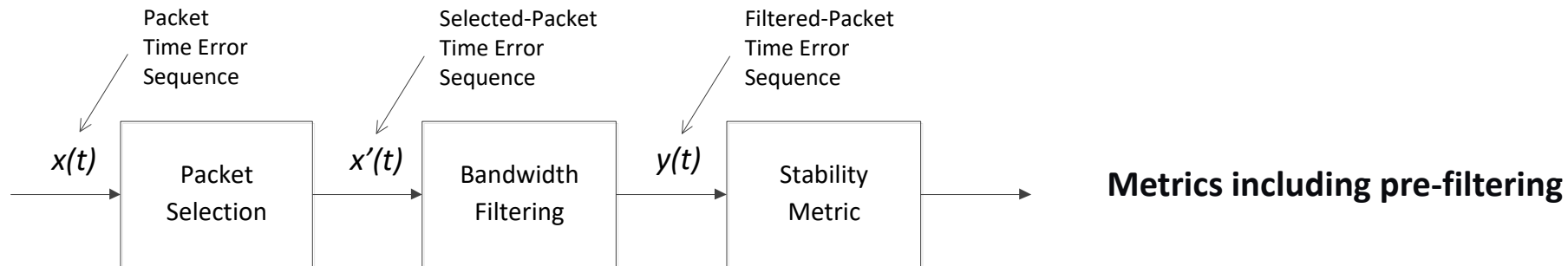
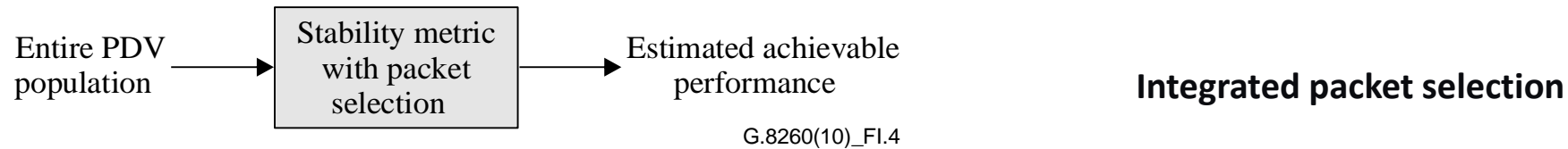
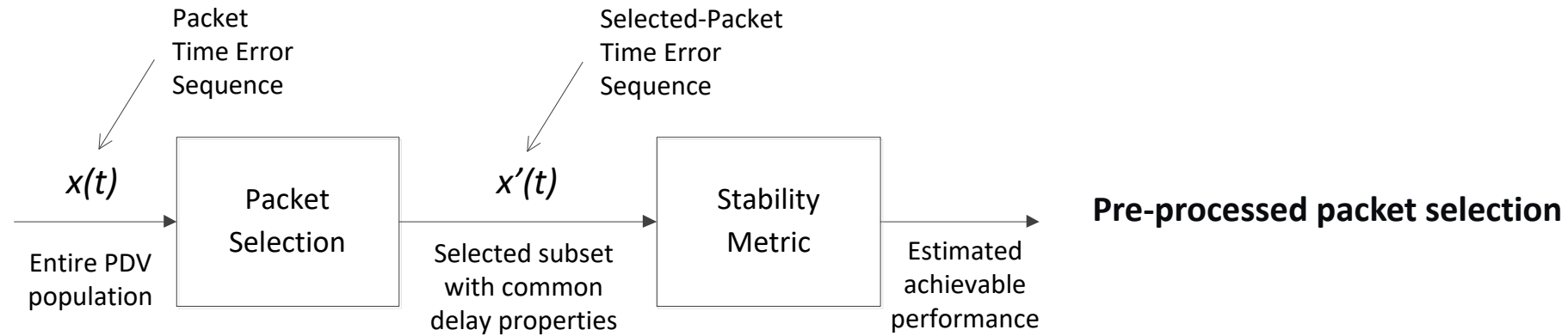

FPC, FPR, FPP: Floor Packet Count/Rate/Percent

PDV metrics studying minimum floor delay packet population

Packet Delay Distribution

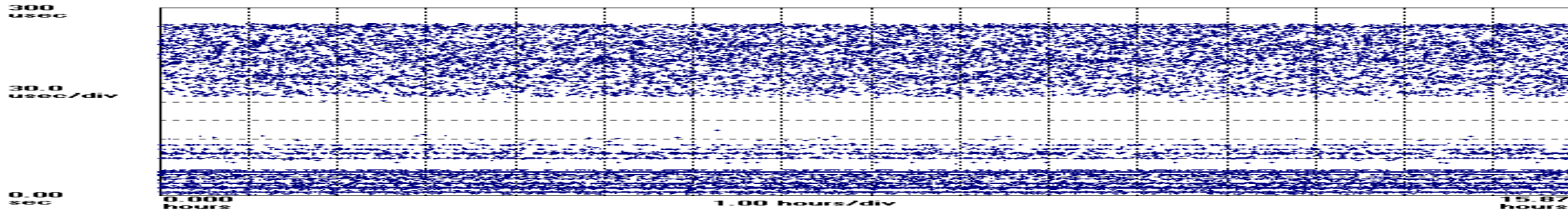

Packet
Delay
Sequence

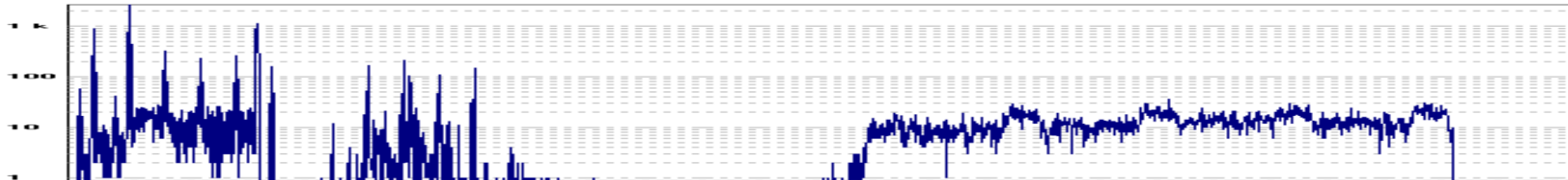

PDF

Minimum: 1.904297 usec Mean: 96.71927 usec
Maximum: 275.2441 usec Standard Deviation: 97.34 usec
Peak to Peak: 273.3 usec Population: 28561 Percentage: 100.0%

Statistics

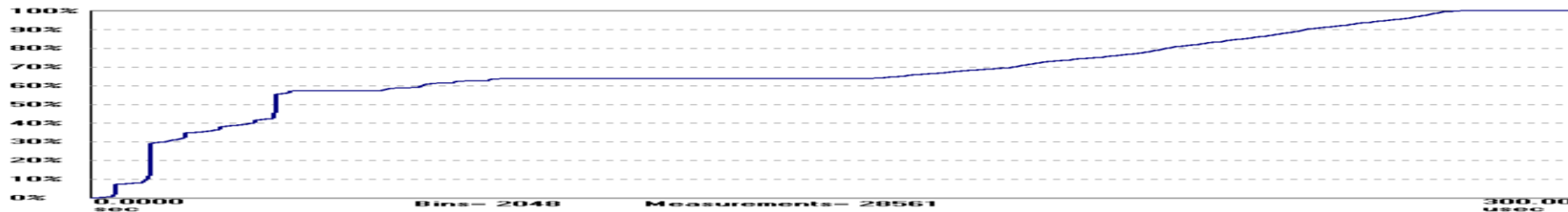

CDF

50 pct: 37.65 us; 90 pct: 245.5 us; 95 pct: 261.9 us; 99 pct: 272.3 us; 99.9 pct: 274.5 us

Time Accuracy and Stability Requirements

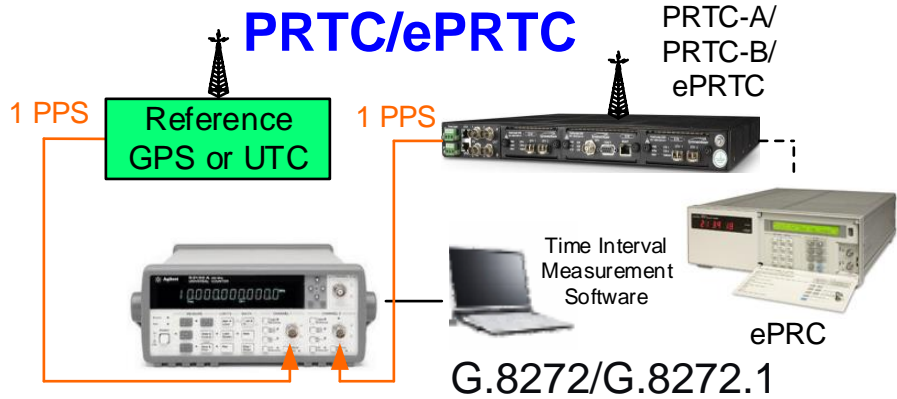

Time Accuracy

Time Error:
 ≤ 100 ns (PRTC-A)
 ≤ 40 ns (PRTC-B)
 ≤ 30 ns (ePRTC)

MTIE

Time Stability

MTIE (PRTC-A) is G.811 with 100 ns maximum
 TDEV (PRTC-A) is G.811 exactly

TDEV

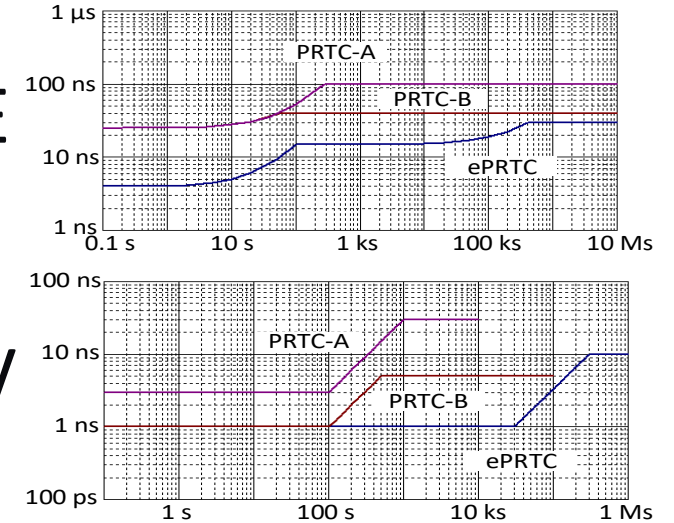

Packet Network Limits

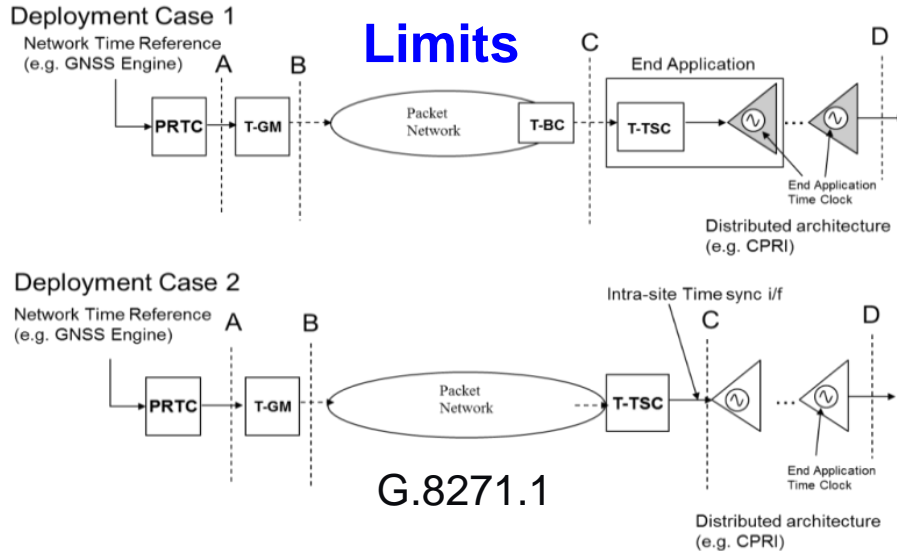

A: Time Error: ≤ 100 ns

C: Time Error: ≤ 1.1 μ s

Time Transport: Two-Way Metrics

Packet Time Transport Metrics

MeanPathDelay: $r(n) = \left(\frac{1}{2}\right) \cdot [R(n) + F(n)]$

TwowayTimeError: $\eta_2(n) = \left(\frac{1}{2}\right) \cdot [R(n) - F(n)]$

pktSelectedMeanPathDelay: $r'(n') = \left(\frac{1}{2}\right) \cdot [R'(n') + F'(n')]$

pktSelectedTwowayTimeError: $\eta_2'(n') = \left(\frac{1}{2}\right) \cdot [R'(n') - F'(n')]$

min2wayTE $\eta_2^m(n) = \left(\frac{1}{2}\right) \cdot [R^m(n) - F^m(n)]$

pct2wayTE $\eta_2^p(n) = \left(\frac{1}{2}\right) \cdot [R^p(n) - F^p(n)]$

cluster2wayTE $\eta_2^c(n) = \left(\frac{1}{2}\right) \cdot [R^c(n) - F^c(n)]$

Ideal F/R: floor
("lucky" packets: fastest)

Ideal 2way TE: zero
(no asymmetry)

psTDISP (min/pct/clst time dispersion): ps2wayTE{y} plotted against psMeanPathDelay{x} as a scatter plot

ps2wayTE statistics: ps2wayTE statistic such as mean, standard deviation, median, 95 percentile plotted as a function of time window tau; min/maxATE

Weighted Average:

$$w(n) = [a \cdot F(n) + (1 - a) \cdot R(n)] \quad \text{where } 0 \leq a \leq 1$$

Time Transport: Two-Way Packet Delay

Forward Packet Delay Sequence

#Start: 2019/03/06 17:15:30

0.0000,	1.47E-6
0.1000,	1.54E-6
0.2000,	1.23E-6
0.3000,	1.40E-6
0.4000,	1.47E-6
0.5000,	1.51E-6

Reverse Packet Delay Sequence

#Start: 2019/03/06 17:15:30

0.0000,	1.11E-6
0.1000,	1.09E-6
0.2000,	1.12E-6
0.3000,	1.13E-6
0.4000,	1.22E-6
0.5000,	1.05E-6

Two-Way Data Set

#Start: 2019/03/06 17:15:30

0.0000,	1.47E-6,	1.11E-6
0.1000,	1.54E-6,	1.09E-6
0.2000,	1.23E-6,	1.12E-6
0.3000,	1.40E-6,	1.13E-6
0.4000,	1.47E-6,	1.22E-6
0.5000,	1.51E-6,	1.05E-6

Minimum Search Sequence

Constructing \hat{f} and \hat{r} from f and r with a 3-sample time window

Time(s)	$f(\mu s)$	$r(\mu s)$	$\hat{f}(\mu s)$	$\hat{r}(\mu s)$
0.0	1.47	1.11		
0.1	1.54	1.09	1.23	1.09
0.2	1.23	1.12		
0.3	1.40	1.13		
0.4	1.47	1.22	1.40	1.05
0.5	1.51	1.05		

min2wayTE

$$\eta_2'(n') = \left(\frac{1}{2}\right) \cdot [R'(n') - F'(n')]$$

Time(s)	min2wayTE(μs)
0.1	-0.07
0.4	-0.18

Time Transport: Two-Way Metrics

2wayTE

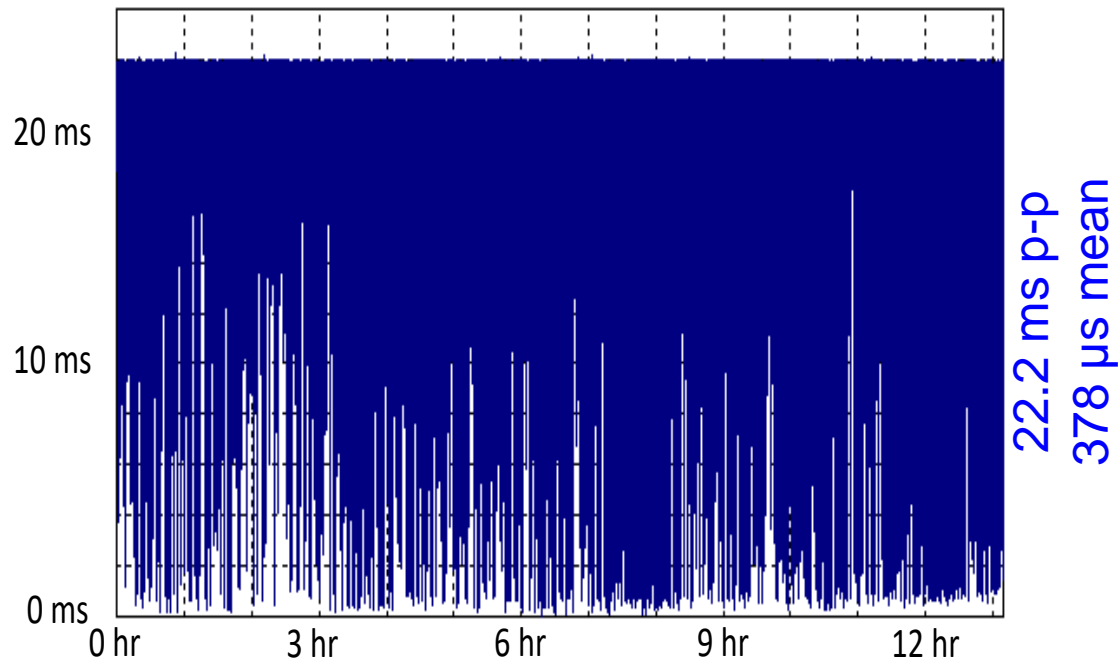

pktSelected2wayTE

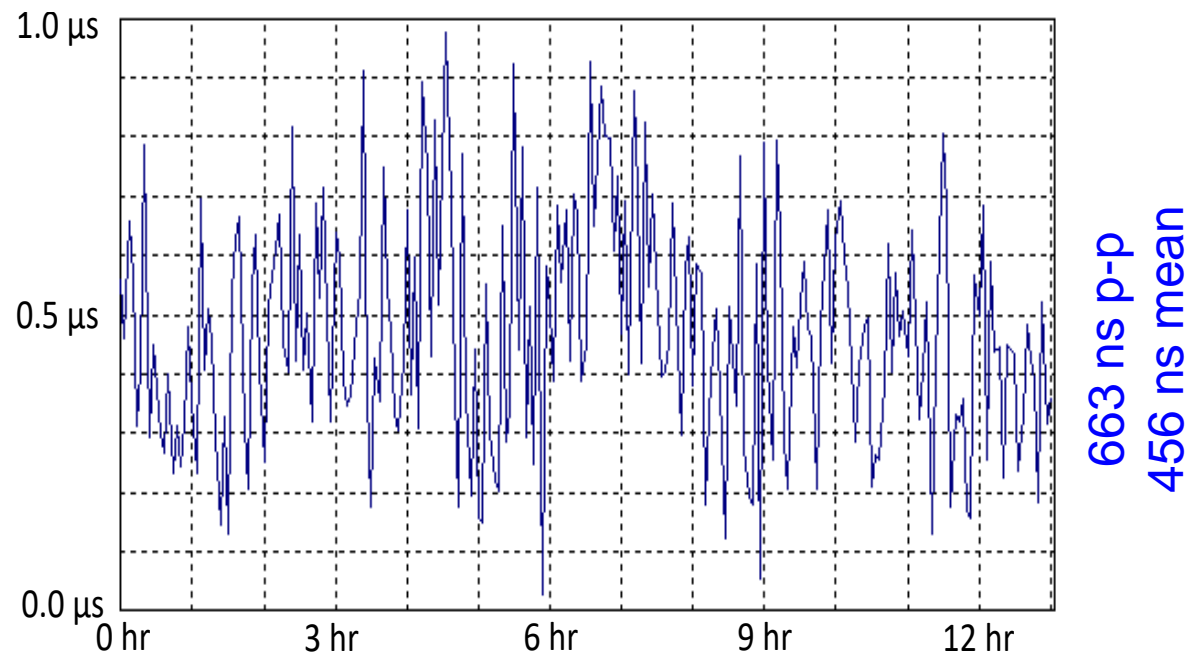

Both 2wayTE and pktSelected2wayTE plots with minimum set to 0. Mean value from unadjusted data.

Selection window = 200s
Selection percentage = 0.25%
Peak-to-peak pktSelected2wayTE = 663 ns
(G.8271.2 APTS limit: <1100 ns)

Two-Way Time Error ↔ Network Asymmetry

Asymmetry in Wireless Backhaul

(Ethernet wireless backhaul asymmetry and IEEE 1588 client 1PPS under these asymmetrical network conditions)

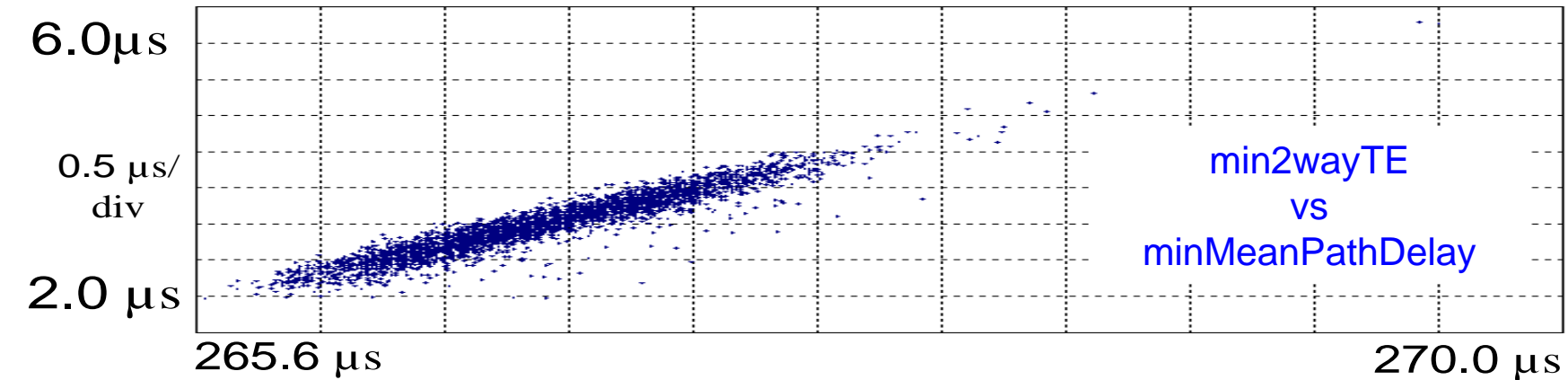

Min
TDISP

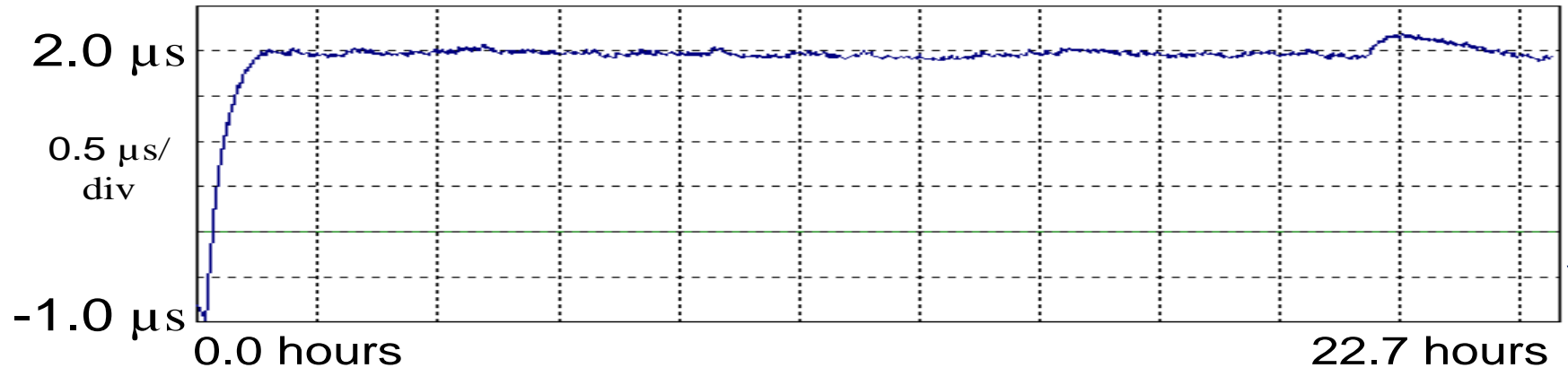

1588
Client 1PPS
vs. GPS

Network Asymmetry

150 km fiber PTP over OTN transport

(2wayTE is 19.1 μ sec which represents the 38.2 μ sec difference between forward and reverse one-way latencies)

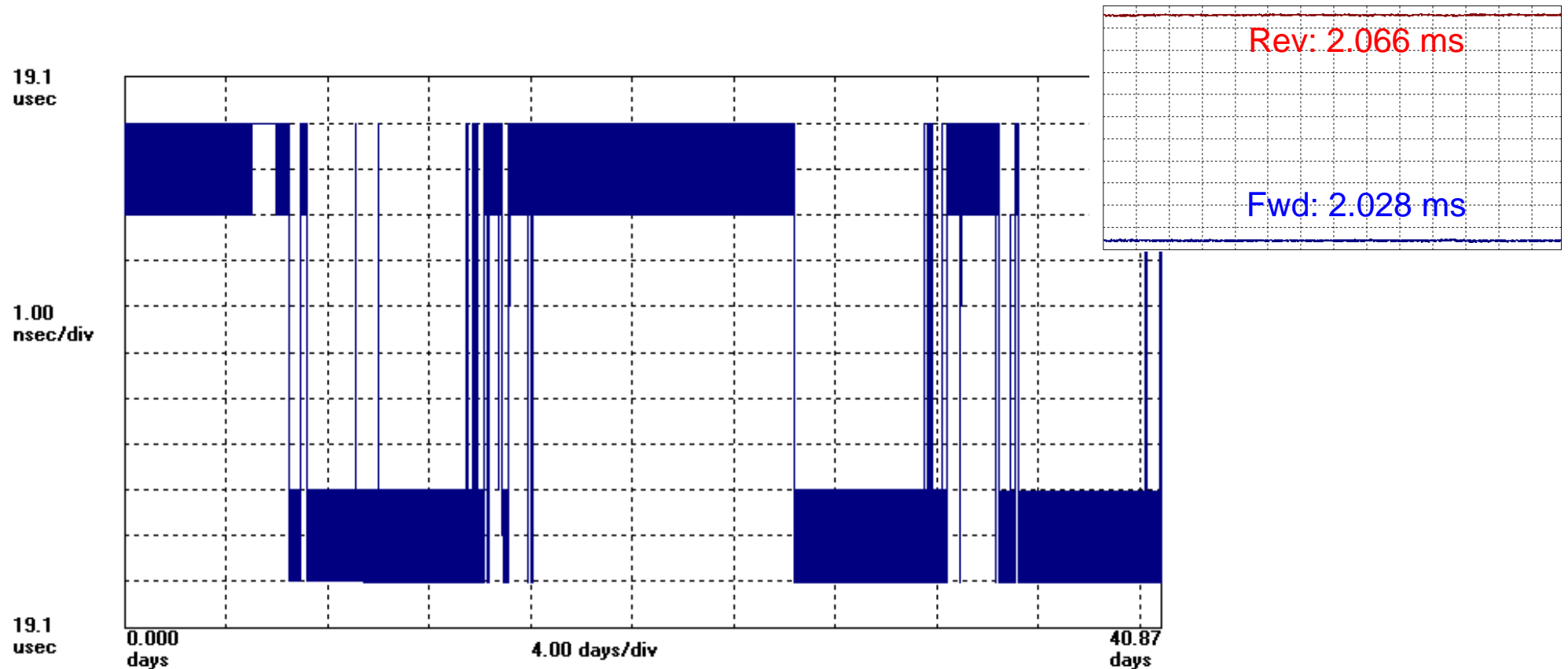

Summary

- **PDV frequency measurements only require a stable reference**
- **PDV time measurements require common time scale reference at both ends of the network being studied (GNSS at both ends is a way to do this)**
- **For frequency transport, asymmetry doesn't matter, and one, the other, or both packet flows can be used**
- **Asymmetry is everywhere, asymmetry is invisible to the IEEE 1588 protocol, thus asymmetry has a direct bearing on the ability to transport time precisely**
- **The “two-way time error” calculation is a direct measure of asymmetry**
- **There are two ways to assess time transport: (1) measuring a 1 PPS reference at the node being studied and (2) measuring a packet signal at the node being studied**
- **Packet metrics for time transport must use both forward and reverse streams together rather than separately as is the case for frequency transport**
- **Packet metrics for time transport can make use of much of the methodology used for packet frequency transport metrics**

Thank you

Lee Cosart

Research Engineer

lee.cosart@microchip.com

Phone: +1-408-428-7833