



Mobile Backhaul Synchronization

In Service Timing SLA Tools for Mobile Networks

Gil Biran, WSTS 2013, San Jose CA



Agenda



- Synchronization SLA tool requirements
- Description of Synchronization SLA tools in different "In Service" modes of operation
- Test Cases for use of Sync Probe SLA tools
- Summery





Synchronization SLA tool requirements

SyncSLA Scope, functions and tools

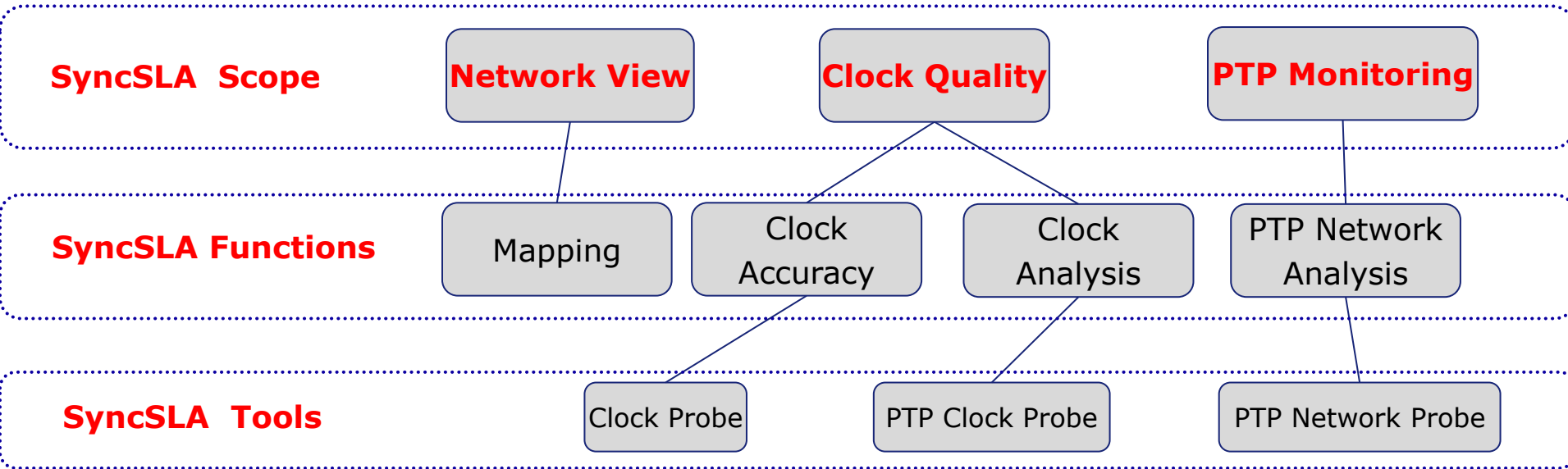

Network View – Topological and status visualization of the synchronization network.

Clock Quality – A set of functions intended to monitor test and analyze the quality of the slave clock

PTP Monitoring – A set of functions intended to monitor test and analyze the end to end PTP routes

Mapping Requirements (PTP Map Case)

- To add a layer of PTP and SyncE over a topology map of the network
- To display Sync Routes and clock distribution based on the user point of interest
- To monitor synchronization topology changes, status and synchronization distribution capabilities
- To display Sync Probe attachment points

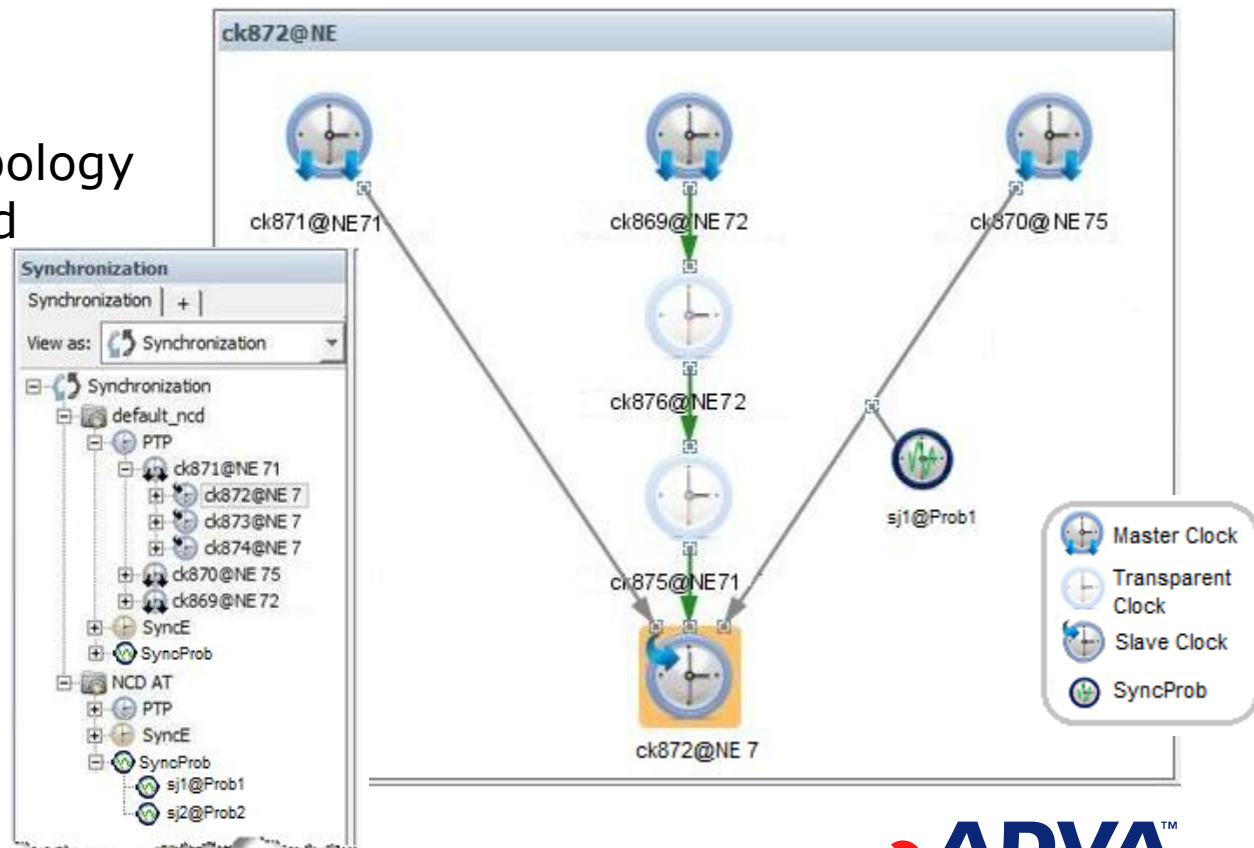

NCD: Network Clock Domain

Clock Analysis Requirements (PTP Clock Probe Case)



- To monitor selected clock source based on collected PTP messages timestamps
- To run multiple concurrent tests per Sync Probe
- To define MTIE Mask and Mask Margin to receive Mask crossing notifications.
- To run the test using NM test framework as option
 - Define tests schedule
 - Monitor the Sync Probe and the on going tests
 - View and export results of historical tests
- To collect Performance Monitoring
 - Clock recovery performance statistics
 - Phase Recovery performance statistics
 - Offset from master statistics
 - TS statuses

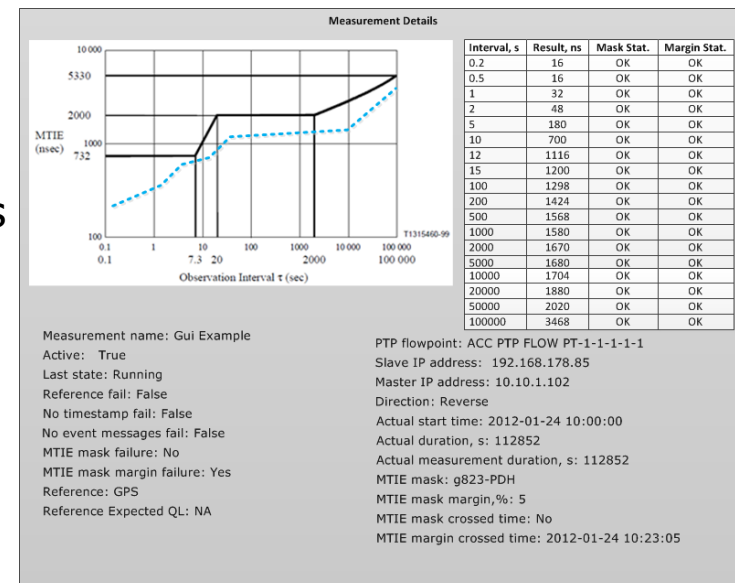

PTP Network Analysis Requirements



- To collect and display end to end PTP communication path performance monitoring for PD, PDV, Frame loss and availability.
 - Collect basic info from Grand master
 - Collect Transparent Clock residence time Performance statistics
 - Collect and display PTP Performance statistics from Boundary Clock
 - Collect and display Performance statistics from Slave clock
- To display different statistics and metrics for PTP
 - PD statistics
 - PDV metrics in different network loads

Entity ID: PTP Probe-1

Summary | 15 Minute | 1 Day | Thresholds

Clear Refresh Automatic Refresh Every 5 Seconds

Path Delay Statistics

Average mean Path Delay, ns	2520	Minimum forward RPDV, ns	656
Minimum mean Path Delay, ns	1034	Average forward RPDV, ns	850
Maximum mean Path Delay, ns	3234	Number of forward RPDV results in low range	455
Average forward Path Delay, ns	1022	Number of forward RPDV results in medium range	320
Minimum forward Path Delay, ns	820	Number of forward RPDV results in high range	820
Maximum forward Path Delay, ns	2120	Total Number of forward RPDV results	4322
Average reverse Path Delay, ns	1230	Minimum reverse RPDV, ns	1230
Minimum reverse Path Delay, ns	760	Average reverse RPDV, ns	760
Maximum reverse Path Delay, ns	2220	Number of reverse RPDV results in low range	2220
		Number of reverse RPDV results in medium range	3222
		Number of reverse RPDV results in high range	1444
		Total Number of reverse RPDV results	4500

Network Usability Score Statistics

Forward direction		Reverse direction	
Current score:	5	Current score:	5
Total time Score=5, s	1233	Total time Score=5, s	1233
Total time Score=4, s	123	Total time Score=4, s	123
Total time Score=3, s	0	Total time Score=3, s	0

PTP Messages Statistics

Sync messages received:	24325
Sync messages lost:	345
Sync messages lost ratio, %	0.004
Delay_Resp messages received:	24670
Delay_Resp messages lost:	0
Delay_Resp messages lost ratio, %	0

SyncSLA Status Display Requirements

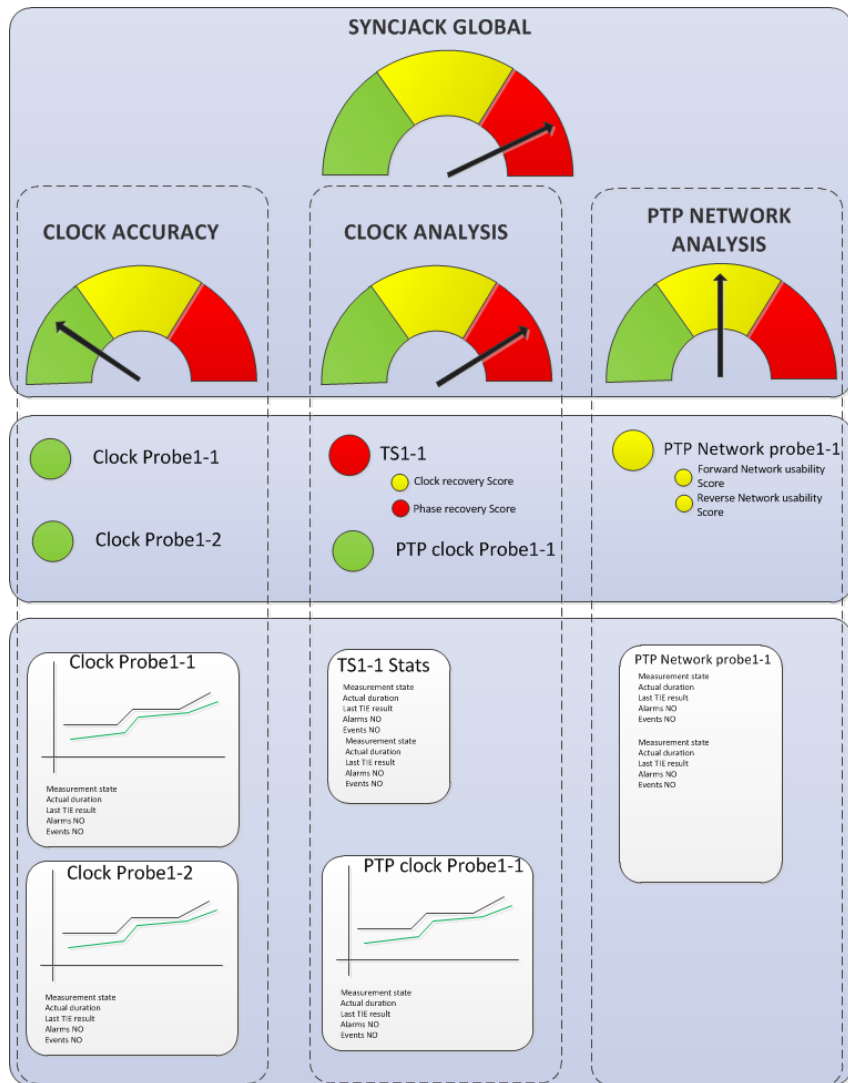

- To support several levels of details for step by step troubleshooting
 - Peeling the onion approach
 - Based on the engineer knowhow
- First level to provide overall Sync Services health indication
- Second level to provide high level health indication of each tool report
- Third level to provide sufficient information for fault localization of each and every test



Description of Synchronization SLA tools in different "In Service" modes of operation

In Service Sync Probing Value Proposition

- Active /Passive Probing and monitoring of multiple telecom physical signals as well as multiple packet timing signals
- Probing of physical signals, packet timing signals and the network PDV can be done simultaneously
 - Ease finding correlation between network impairments and clock performance
- Bi-directional Probing of network PDV Behavior
 - Impact Frequency Delivery Performance
- Measurement of PTP network asymmetry
 - Impact Phase and ToD Delivery Performance
- In-service Probing enable Synchronization as a Service with Guaranteed SLA

Type of Probing Tools for Sync SLA



▶ **Clock Accuracy - 2 x Clock Probe:**

- ▶ Calculate MTIE between physical source and reference signals
- ▶ Programmable Source and reference signals

▶ **Clock Analysis**

▶ **4 x PTP Clock Probe**

- ▶ Calculate packet MTIE between Physical reference signal and packet flow
- ▶ Probe Master to Slave or Slave to master traffic
- ▶ Support parallel and tapping modes

▶ **T-SC score** – simple score of internal slave clock

▶ **PTP Network Analysis - 1 x PTP Network Probe**

- ▶ Delay and delay variation performance statistics, Network usability statistics, Packet loss statistics

T-SC and T-BC Self Monitoring



- ▶ Internal T-SC and T-BC 1PPS and clock outputs can be monitored simultaneously using Two Clock Probes and GPS/external reference
- ▶ The network delay asymmetry can be measured using the PTP network probe statistics (Sync Min Path Delay and Mean Min Path Delay)

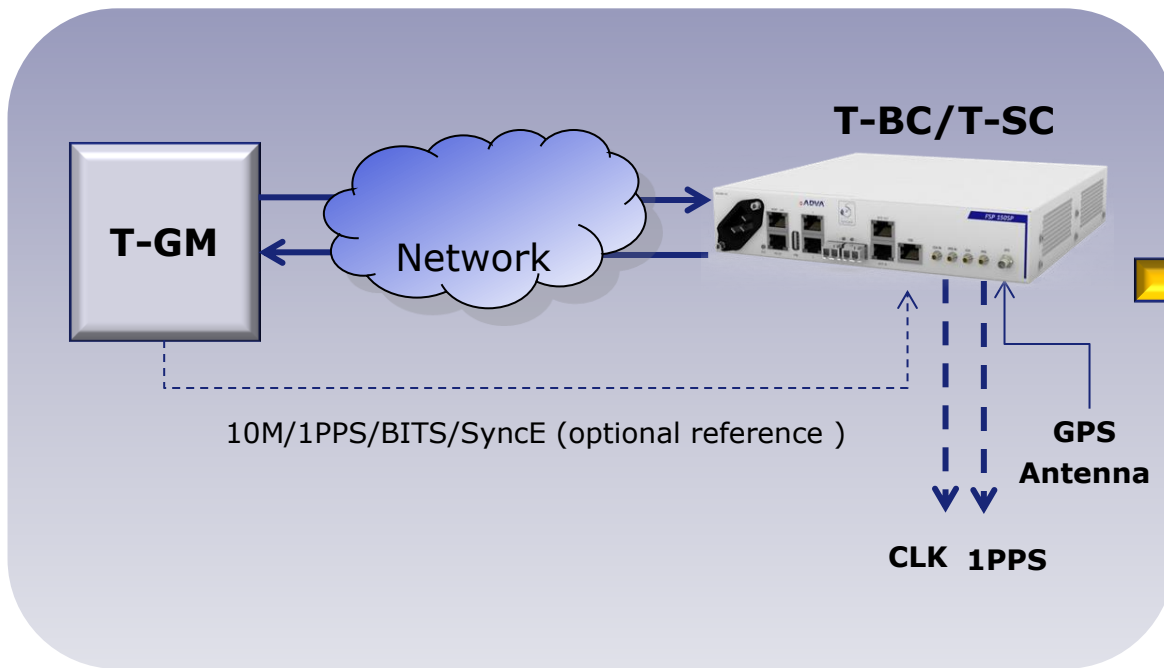

1PPS and CLK MTIE

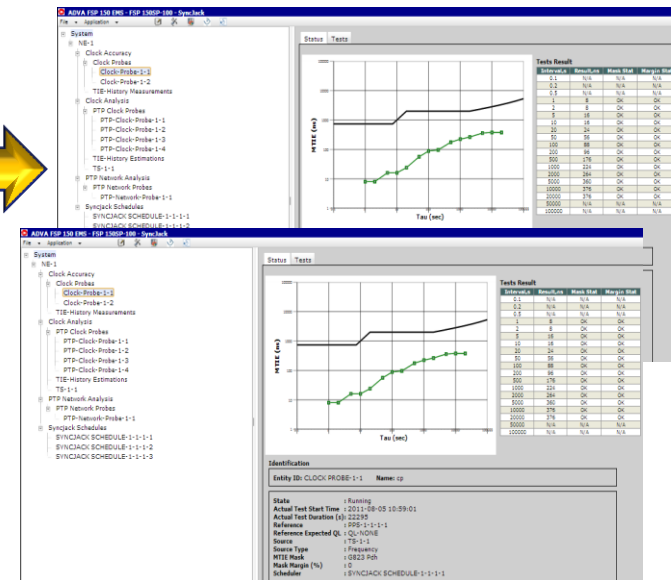

Testing T-SC and T-BC 1PPS and clock outputs can be monitored simultaneously using Two Clock Probes



- T-SC and T-BC 1PPS and clock outputs can be monitored simultaneously using Two Clock Probes

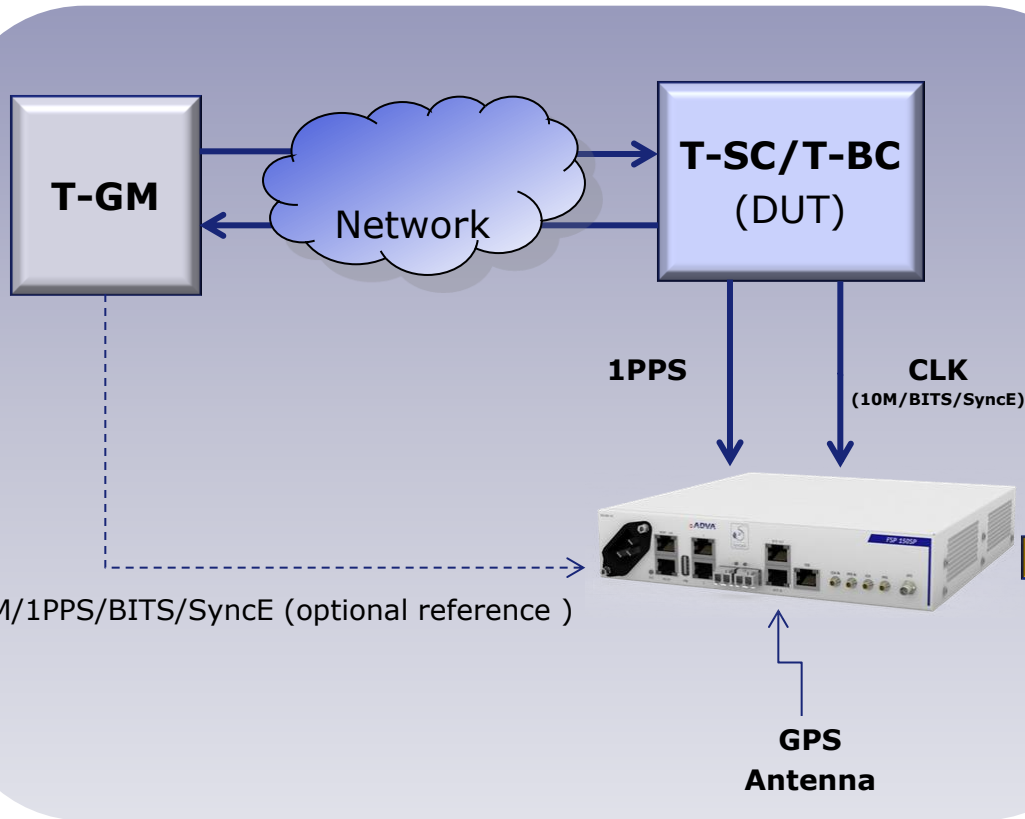

1PPS and CLK MTIE

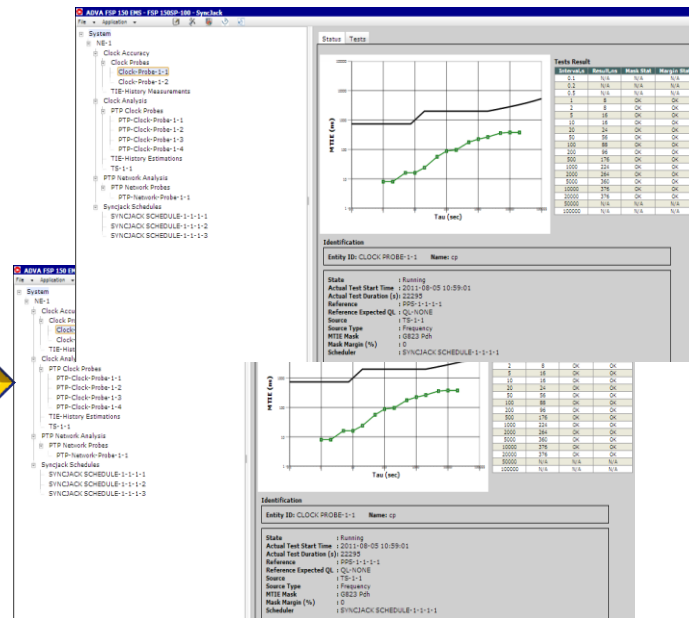

Probing T-SC



- T-SC packet timing signal (T3), 1PPS and clock outputs can be monitored simultaneously using Two Clock Probes and One PTP clock Probe

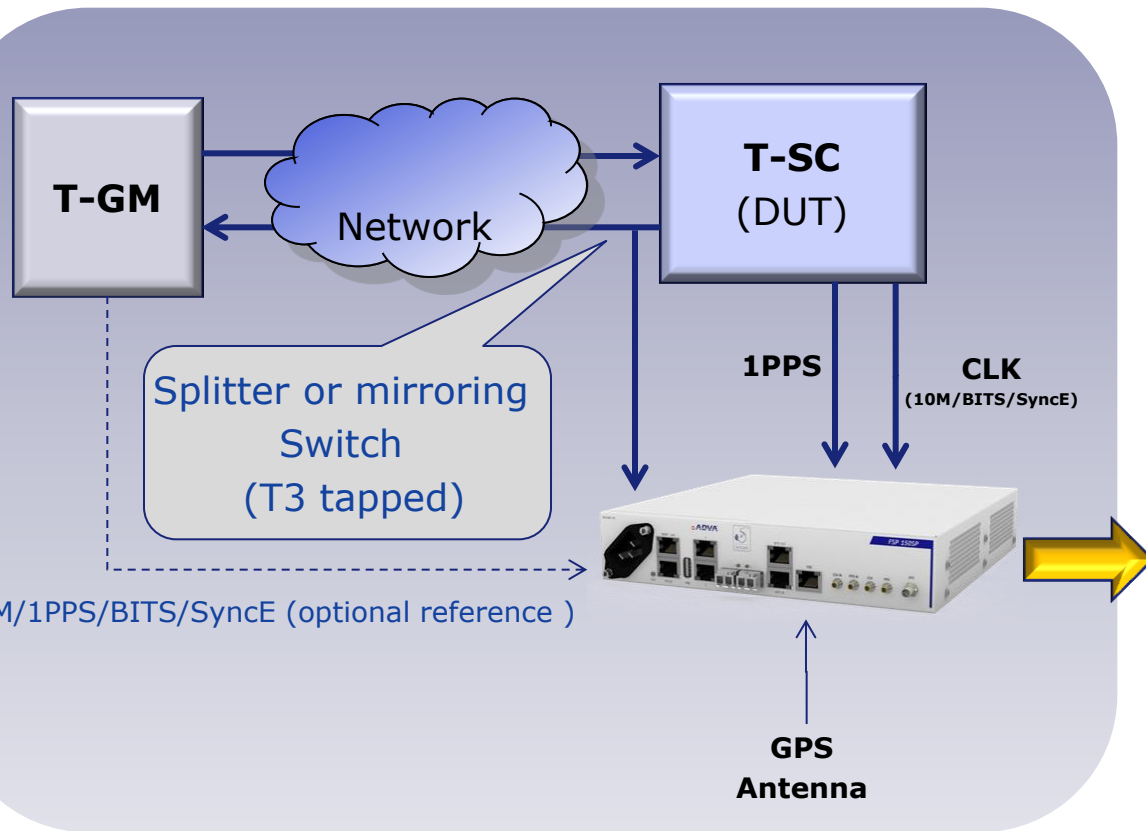

1PPS and CLK MTIE

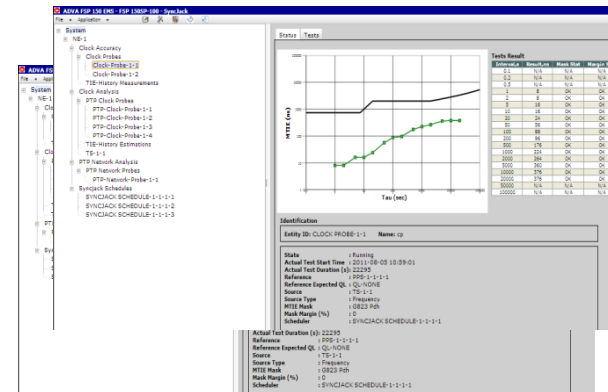

Packet MTIE based on T3

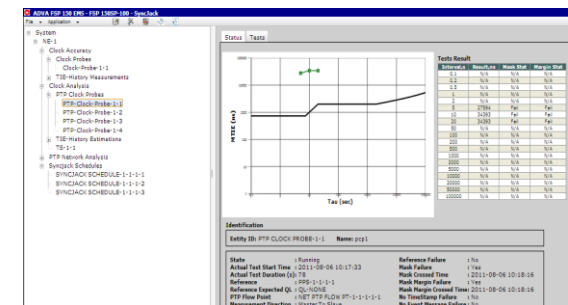

Probing T-BC



- 1PPS and clock outputs together with T-BC slave & master packet timing signal (T3 and T1), can be monitored simultaneously using Two Clock Probes and Two PTP clock Probes

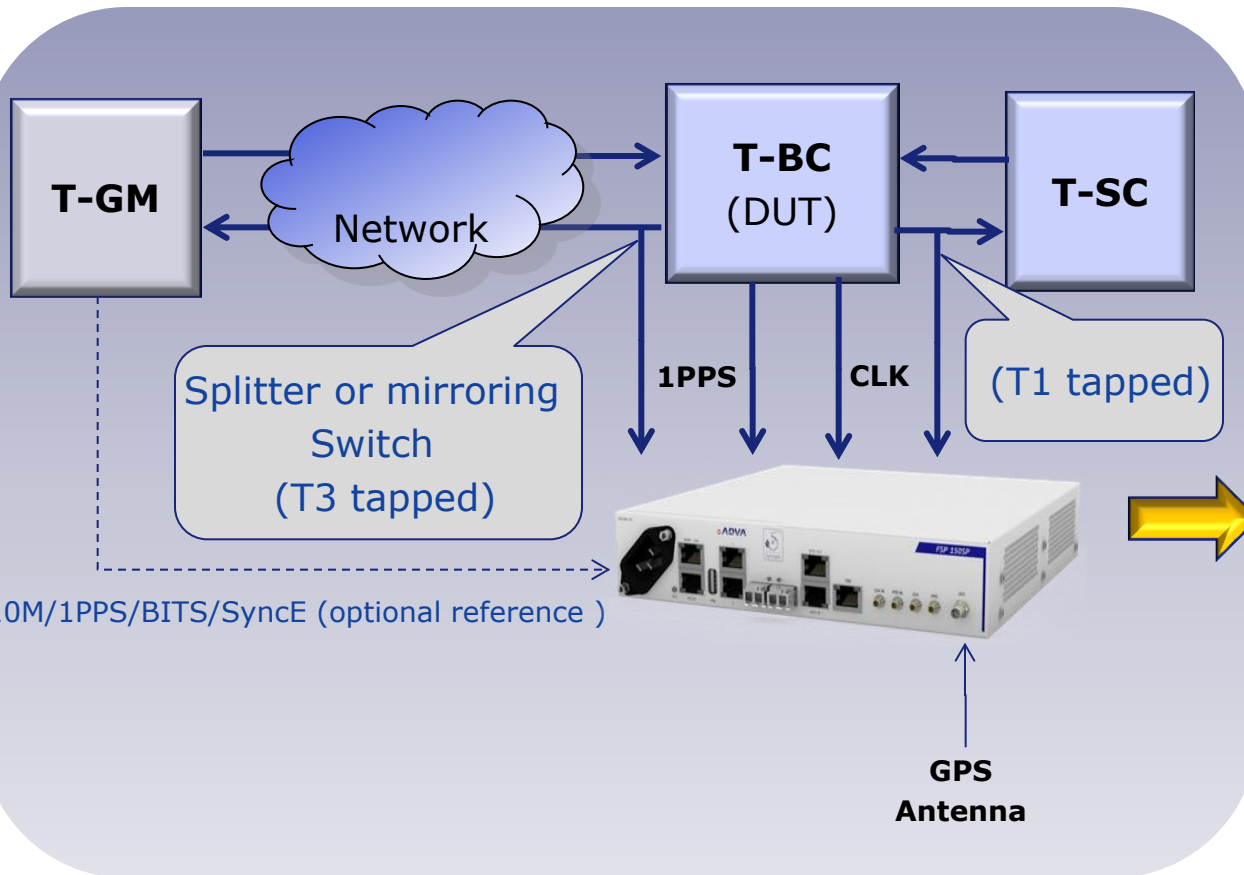

1PPS and CLK MTIE

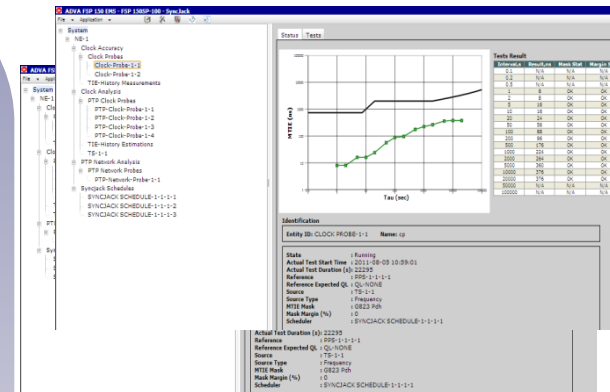

Packet MTIE based on T3,T1

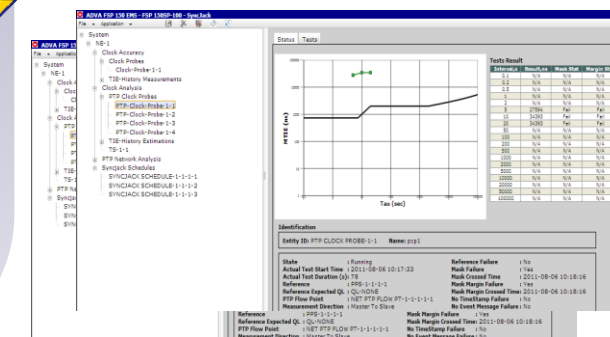

PTP Network Active Probe



- ▶ Active probe uses the internal Telecom slave packets exchanged
- ▶ The Sync Probe can probe the network and recover the clock simultaneously
- ▶ Provides PTP network Probe Statistics and Network Usability Score

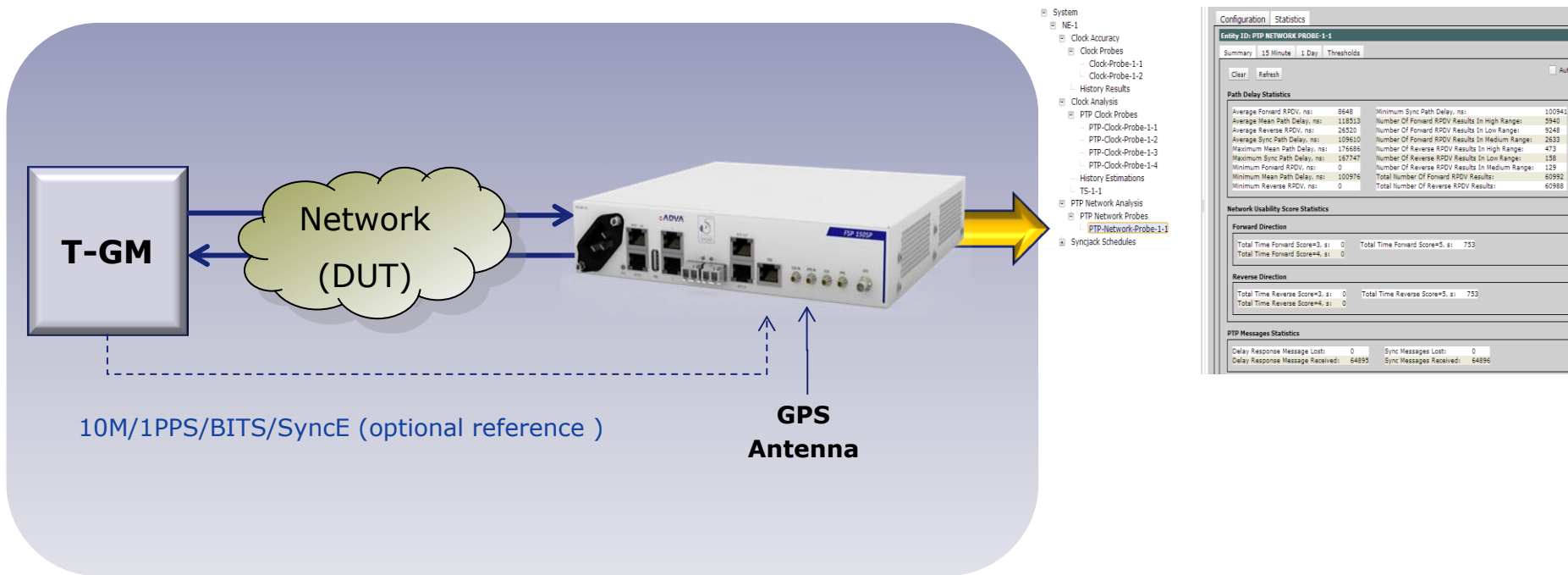

PTP Network Passive Probe



- Provides PTP network Probe Statistics and Network Usability Score based on T1, T2, T3 and T4 information

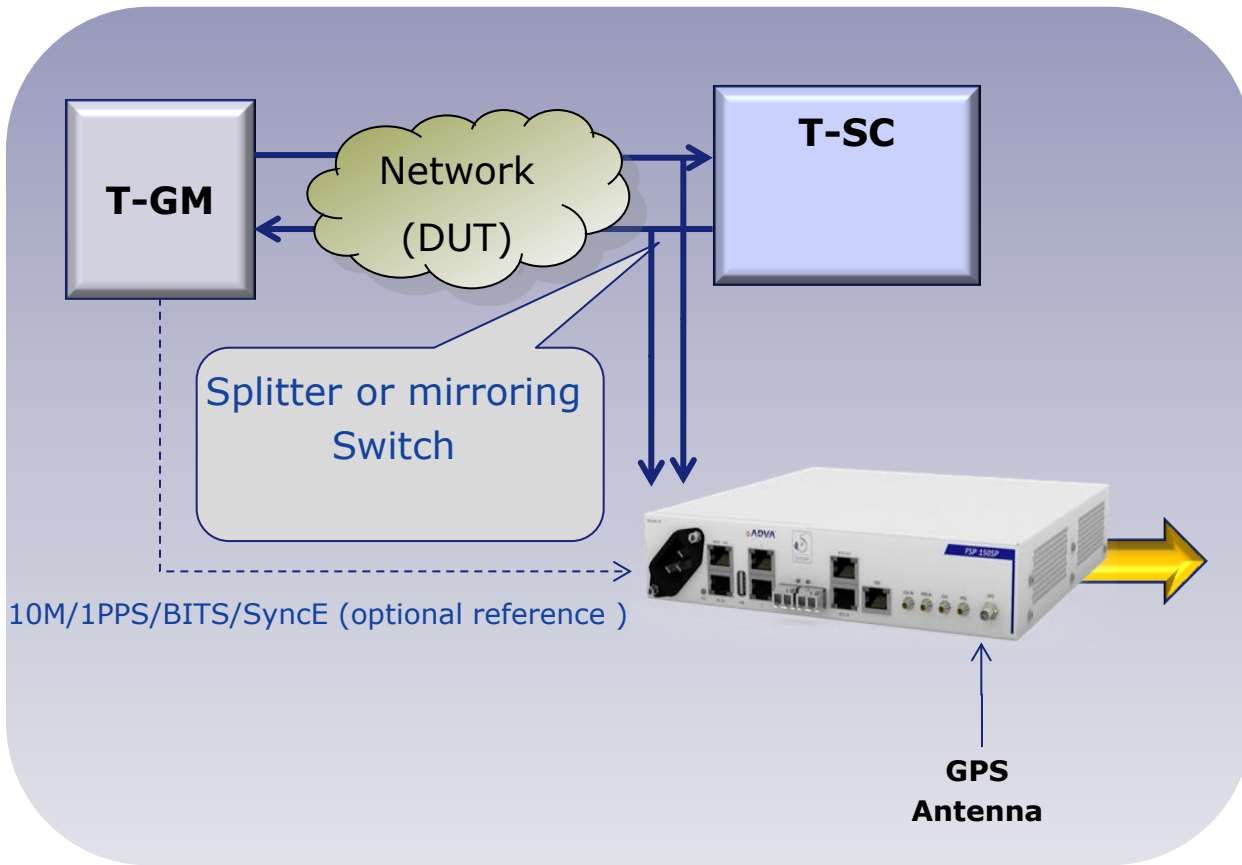

- System
 - NE-1
 - Clock Accuracy
 - Clock Probes
 - Clock-Probe-1-1
 - Clock-Probe-1-2
 - History Results
 - Clock Analysis
 - PTP Clock Probes
 - PTP-Clock-Probe-1-1
 - PTP-Clock-Probe-1-2
 - PTP-Clock-Probe-1-3
 - PTP-Clock-Probe-1-4
 - History Estimations
 - TS-1-1
 - PTP Network Analysis
 - PTP Network Probes
 - PTP-Network-Probe-1-1
 - Synckak Schedules

Path Delay Statistics	
Average Forward RPDV, ns:	8648
Average Mean Path Delay, ns:	118513
Average Reverse RPDV, ns:	26520
Average Sync Path Delay, ns:	109620
Maximum Mean Path Delay, ns:	176686
Maximum Sync Path Delay, ns:	167747
Minimum Forward RPDV, ns:	0
Minimum Mean Path Delay, ns:	100976
Minimum Reverse RPDV, ns:	0
Minimum Sync Path Delay, ns:	100941
Number Of Forward RPDV Results In High Range:	5940
Number Of Forward RPDV Results In Low Range:	5248
Number Of Forward RPDV Results In Medium Range:	2332
Number Of Reverse RPDV Results In High Range:	473
Number Of Reverse RPDV Results In Low Range:	158
Number Of Reverse RPDV Results In Medium Range:	129
Total Number Of Forward RPDV Results:	60992
Total Number Of Reverse RPDV Results:	60988

Network Usability Score Statistics	
Forward Direction	
Total Time Forward Score#3, s:	0
Total Time Forward Score#4, s:	0
Total Time Forward Score#5, s:	733
Reverse Direction	
Total Time Reverse Score#3, s:	0
Total Time Reverse Score#4, s:	0
Total Time Reverse Score#5, s:	733

PTP Messages Statistics	
Delay Response Message Lost:	0
Delay Response Message Received:	64895
Sync Messages Lost:	0
Sync Messages Received:	64896

Probing Clock and Network Simultaneously

- ▶ Clock probes, PTP Clock probes and PTP network probe can work simultaneously, therefore both T-SC and network can be monitored at the same time

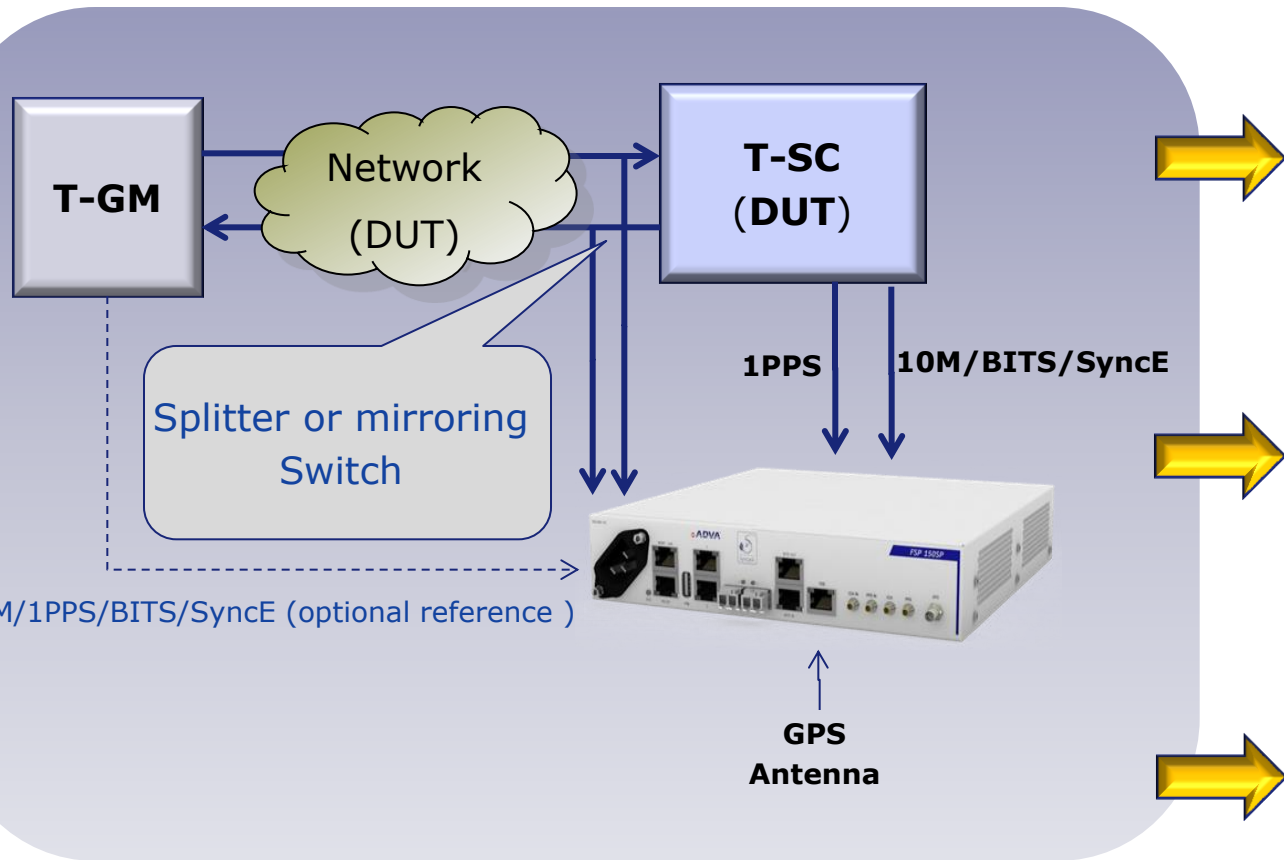

1PPS and CLK MTIE

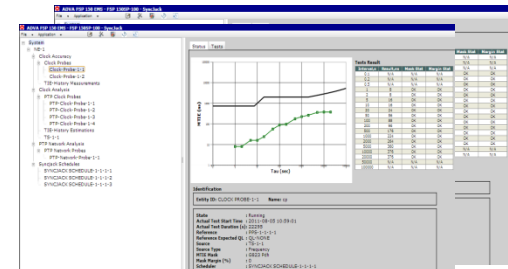

Packet MTIE based on T3

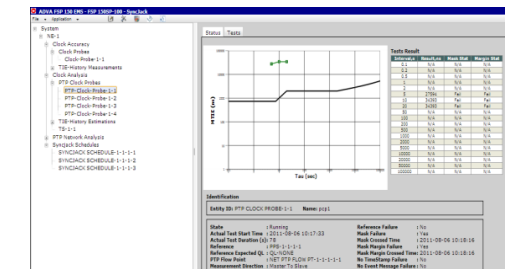

PTP network Probe Statistics and Network Usability Score

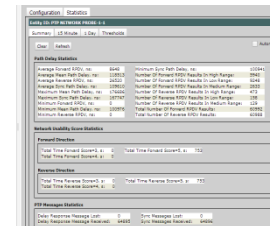



Test Cases for use of Sync Probe SLA tools

Set-up description for Sync Probe test cases results

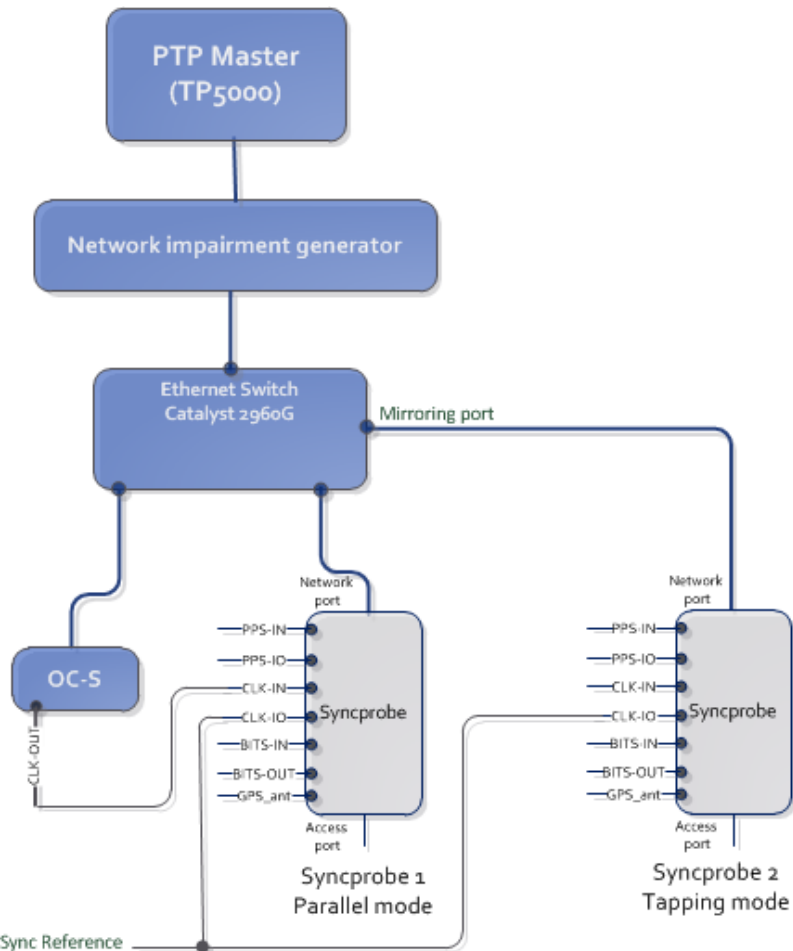

- PTP Master – Symmetricom TP5000
- OC-S – Tested device with IEEE1588v2 Ordinary Clock-Slave (OC-S) functionality
- Sync Probe-1 operates OC-S and runs SyncSLA tools
- Sync Probe-2 runs only SyncSLA tools
- Impairment generator runs test case 12 ITU-T G.8261
- The Ethernet switch is configured with mirroring mode to copy PTP frames to the Mirroring Port (in the real deployment optical splitter may be used instead)
- Sync reference is always connected to the Sync Probe-2 and in some test cases connected to the Sync Probe-1 (PPS, 10MHz, BITS, Sync-E and GPS antenna)

MTIE measurements of OC-S under test Vs. OC-S in Sync Probe – Clock Accuracy

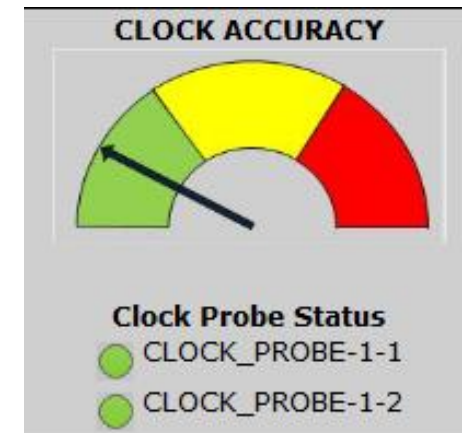
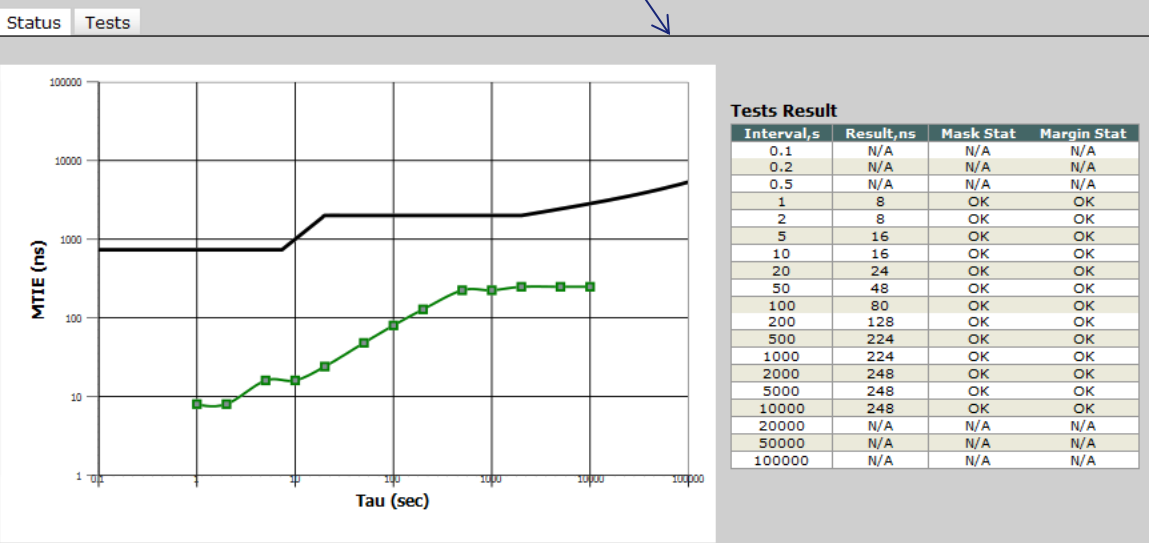
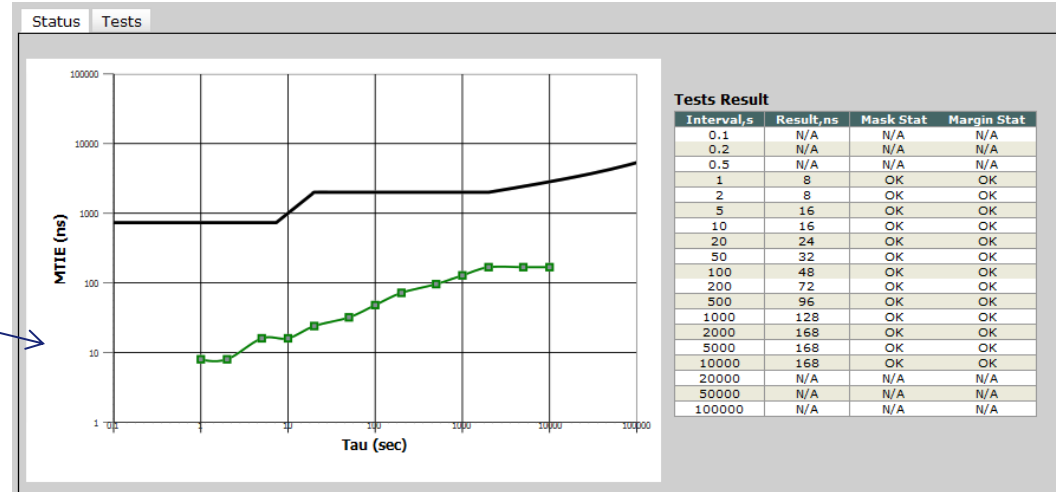
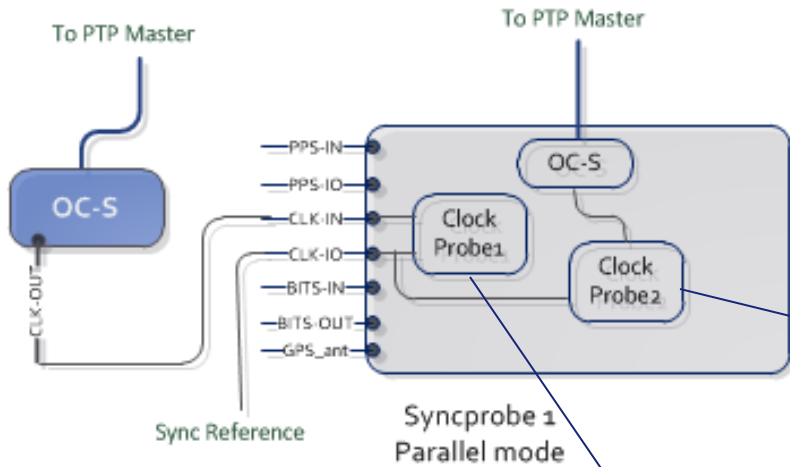

Simultaneous MTIE measurements of multiple remote OC-S nodes – Clock Analysis

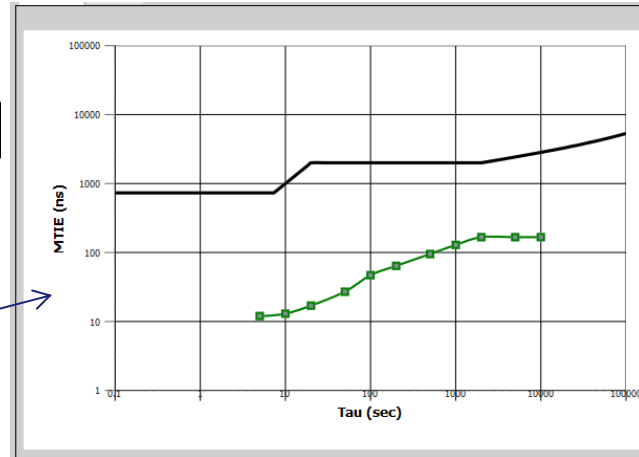
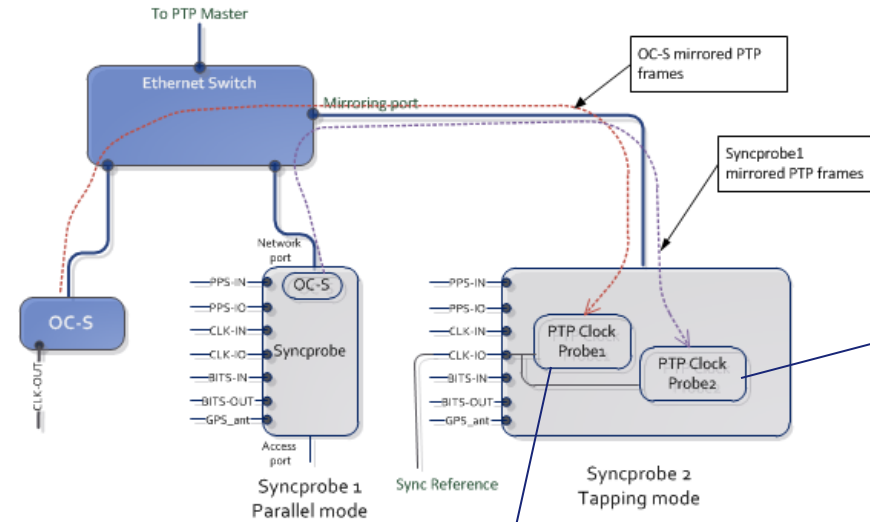

Tests Result

Interval,s	Result,ns	Mask Stat	Margin Stat
0.1	N/A	N/A	N/A
0.2	N/A	N/A	N/A
0.5	N/A	N/A	N/A
1	N/A	N/A	N/A
2	N/A	N/A	N/A
5	12	OK	OK
10	13	OK	OK
20	17	OK	OK
50	27	OK	OK
100	47	OK	OK
200	64	OK	OK
500	95	OK	OK
1000	129	OK	OK
2000	167	OK	OK
5000	167	OK	OK
10000	167	OK	OK
20000	N/A	N/A	N/A
50000	N/A	N/A	N/A
100000	N/A	N/A	N/A

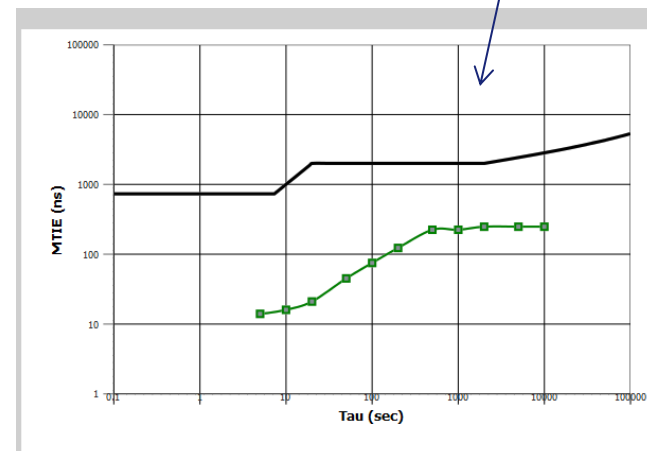

Tests Result

Interval,s	Result,ns	Mask Stat	Margin Stat
0.1	N/A	N/A	N/A
0.2	N/A	N/A	N/A
0.5	N/A	N/A	N/A
1	N/A	N/A	N/A
2	N/A	N/A	N/A
5	14	OK	OK
10	16	OK	OK
20	21	OK	OK
50	45	OK	OK
100	75	OK	OK
200	123	OK	OK
500	224	OK	OK
1000	224	OK	OK
2000	248	OK	OK
5000	248	OK	OK
10000	248	OK	OK
20000	N/A	N/A	N/A
50000	N/A	N/A	N/A
100000	N/A	N/A	N/A

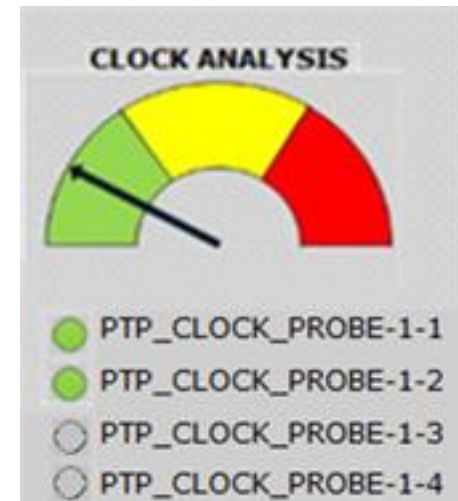

PTP communication path PM and statistics

PTP Network Analysis

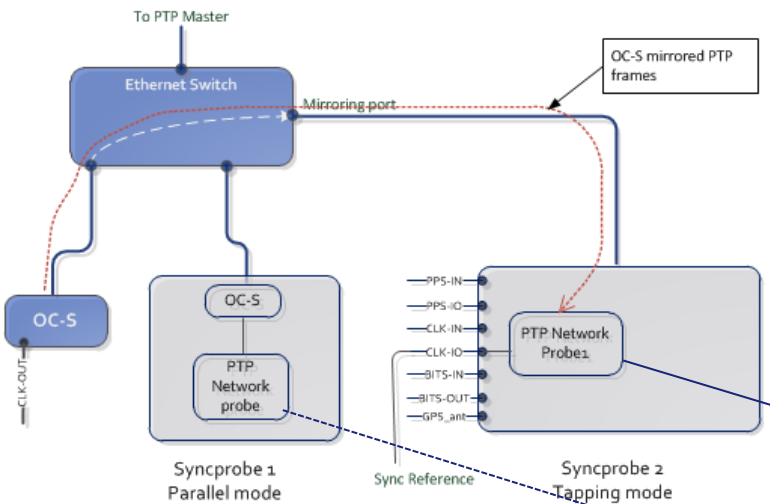

Entity ID: PTP Probe-1

Summary | 15 Minute | 1 Day | Thresholds

Clear Refresh Automatic Refresh Every 5 Seconds

Entity ID: PTP Probe-1

Summary | 15 Minute | 1 Day | Thresholds

Clear Refresh Automatic Refresh Every 5 Seconds

Path Delay Statistics

Average mean Path Delay, ns	2520	Minimum forward RPDV, ns	656
Minimum mean Path Delay, ns	1034	Average forward RPDV, ns	850
Maximum mean Path Delay, ns	3234	Number of forward RPDV results in low range	455
Average forward Path Delay, ns	1022	Number of forward RPDV results in medium range	320
Minimum forward Path Delay, ns	820	Number of forward RPDV results in high range	820
Maximum forward Path Delay, ns	2120	Total Number of forward RPDV results	4322
Average reverse Path Delay, ns	1230	Minimum reverse RPDV, ns	1230
Minimum reverse Path Delay, ns	760	Average reverse RPDV, ns	760
Maximum reverse Path Delay, ns	2220	Number of reverse RPDV results in low range	2220
		Number of reverse RPDV results in medium range	3222
		Number of reverse RPDV results in high range	1444
		Total Number of reverse RPDV results	4500

Network Usability Score Statistics

Forward direction		Reverse direction	
Current score:	5	Current score:	5
Total time Score=5, s	1233	Total time Score=5, s	1233
Total time Score=4, s	123	Total time Score=4, s	123
Total time Score=3, s	0	Total time Score=3, s	0

PTP Messages Statistics

Sync messages received:	24325
Sync messages lost:	345
Sync messages lost ratio, %:	0.004
Delay_Resp messages received:	24670
Delay_Resp messages lost:	0
Delay_Resp messages lost ratio, %:	0

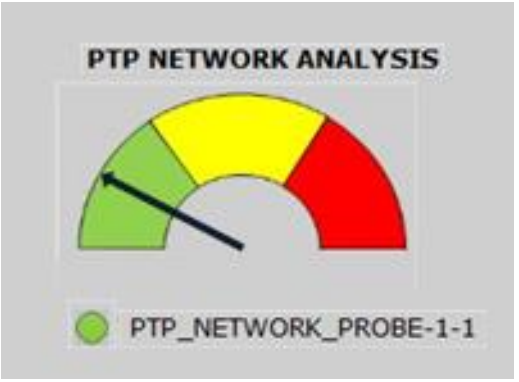

- With and Without Reference Clock

Managing Synchronization Networks



Network View

Visibility of Sync Routes and clock distribution



Clock Analysis & Accuracy

Monitor in service clock performance



PTP Network Analysis

Monitor in service PTP performance for SLA Assurance

Synchronization as integrated part of mobile backhaul service
Sync SLA should be provided and managed like any L2/L3 service

Sync SLA is mandatory for successful LTE-A deployment



Thank you

GBiran@advaoptical.com



IMPORTANT NOTICE

The content of this presentation is strictly confidential. ADVA Optical Networking is the exclusive owner or licensee of the content, material, and information in this presentation. Any reproduction, publication or reprint, in whole or in part, is strictly prohibited.

The information in this presentation may not be accurate, complete or up to date, and is provided without warranties or representations of any kind, either express or implied. ADVA Optical Networking shall not be responsible for and disclaims any liability for any loss or damages, including without limitation, direct, indirect, incidental, consequential and special damages, alleged to have been caused by or in connection with using and/or relying on the information contained in this presentation.

Copyright © for the entire content of this presentation: ADVA Optical Networking.