

Characterizing Network Time Performance

Lee Cosart

lee.cosart@microsemi.com

WSTS 2015

Introduction

- Frequency transport
 - One-way: forward & reverse packet streams can be used separately
 - Asymmetry is irrelevant
 - Stable frequency needed
 - PRC (primary reference clock) needed
 - GNSS/GPS antenna cable compensation/calibration not needed
 - GSM frequency backhaul (50 ppb) is example technology

- Time transport
 - Two-way: forward & reverse packet streams used together
 - Asymmetry is critical
 - Stable time and frequency needed
 - PRTC (primary reference time clock) needed
 - GNSS/GPS antenna cable compensation/calibration needed
 - LTE-TDD time/phase (1.5 μ sec) is example technology

Testing Time “Physical” vs. “Packet”

■ “1 PPS” (Single Point Measurement)

- Measurements are made at a single point – a single piece of equipment in a single location - a phase detector with reference - is needed

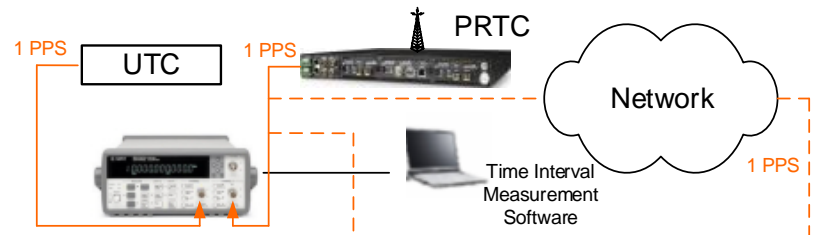
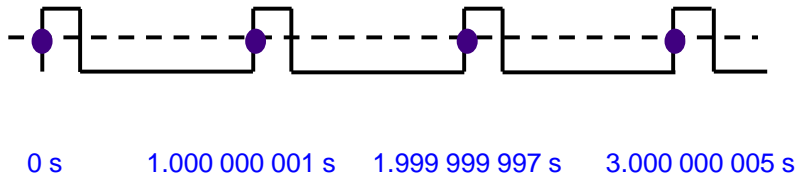

■ “Packet” (Dual Point Measurement)

- Measurements are constructed from packets time-stamped at two points – in general two pieces of equipment, each with a reference, at two different locations – are needed

Timestamp A

Timestamp B

F	1286231440.883338640	1286231440.883338796
R	1286231441.506929352	1286231441.506929500
F	1286231441.883338640	1286231441.883338796
R	1286231442.506929352	1286231442.506929500
F	1286231442.883338640	1286231442.883338796
R	1286231443.506929352	1286231443.506929516

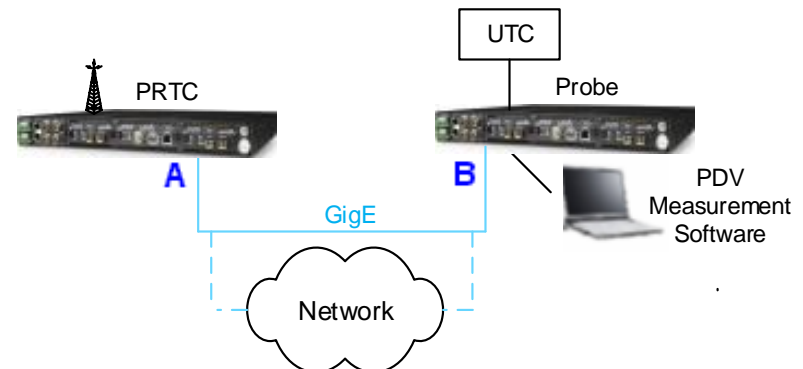

Time Accuracy and Stability Requirements

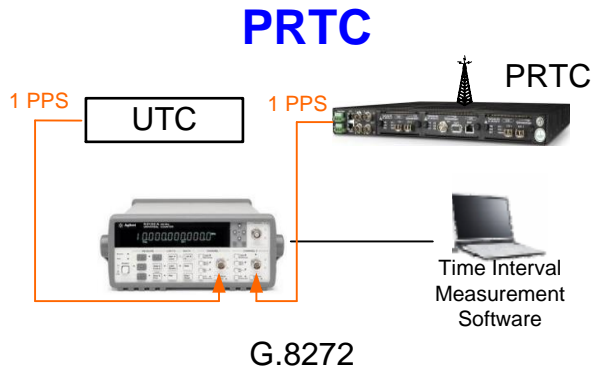

Time Accuracy
Time Error: $\leq 100\text{ns}$

Time Stability \rightarrow TDEV

MTIE

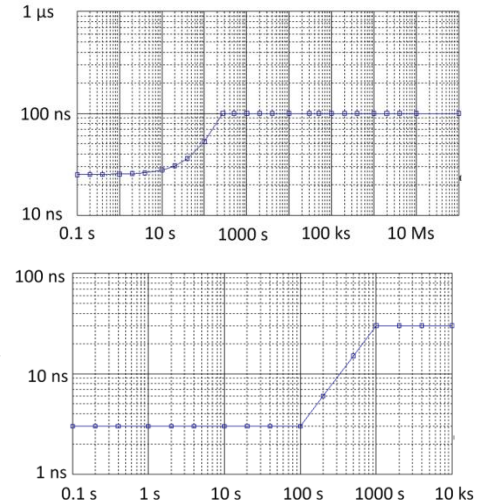

MTIE is G.811 with 100 ns maximum
TDEV is G.811 exactly

Packet Network Limits

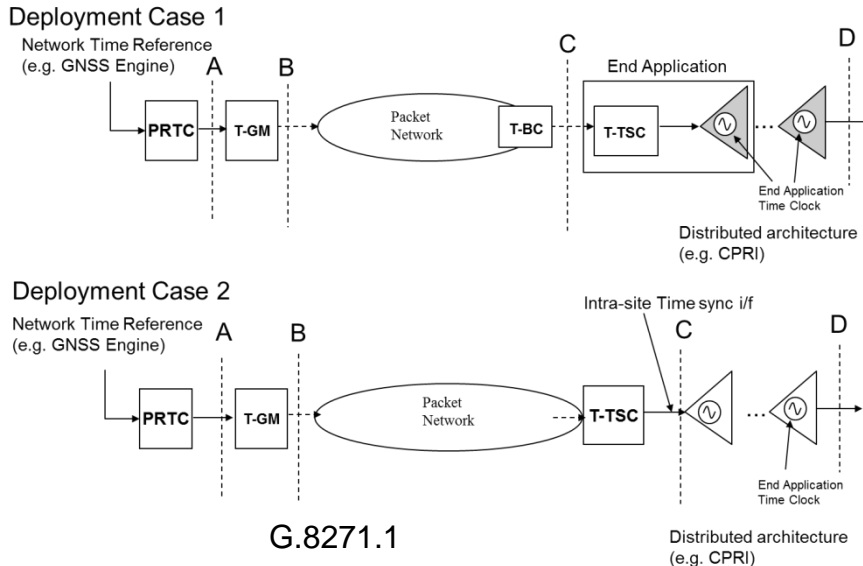

A: Time Error: $\leq 100\text{ns}$

C: Time Error: $\leq 1.1\mu\text{s}$

Stability metrics for PDV

■ Packet Selection Processes

1) **Pre-processed:** packet selection step prior to calculation

- Example: **TDEV(PDVmin)** where *PDVmin* is a new sequence based on minimum searches on the original PDV sequence

2) **Integrated:** packet selection integrated into calculation

- Example: **minTDEV(PDV)**

■ Packet Selection Methods

- Minimum: $x_{\min}(i) = \min[x_j] \text{ for } (i \leq j \leq i + n - 1)$

- Percentile: $x'_{pct_mean}(i) = \frac{1}{m} \sum_{j=0}^b x'_{j+i}$

- Band: $x'_{band_mean}(i) = \frac{1}{m} \sum_{j=a}^b x'_{j+i}$

- Cluster:
$$x(n\tau_0) = \frac{\sum_{i=0}^{(K-1)} w((nK+i)\tau_p) \cdot \phi(n,i)}{\sum_{i=0}^{(K-1)} \phi(n,i)} \quad \phi(n,i) = \begin{cases} 1 & \text{for } |w(nK+i) - \alpha(n)| < \delta \\ 0 & \text{otherwise} \end{cases}$$

Packet Selection Windows

■ Windows

- **Non-overlapping windows**
(next window starts at prior window stop)
- **Skip-overlapping windows**
(windows overlap but starting points skip over N samples)
- **Overlapping windows**
(windows slide sample by sample)

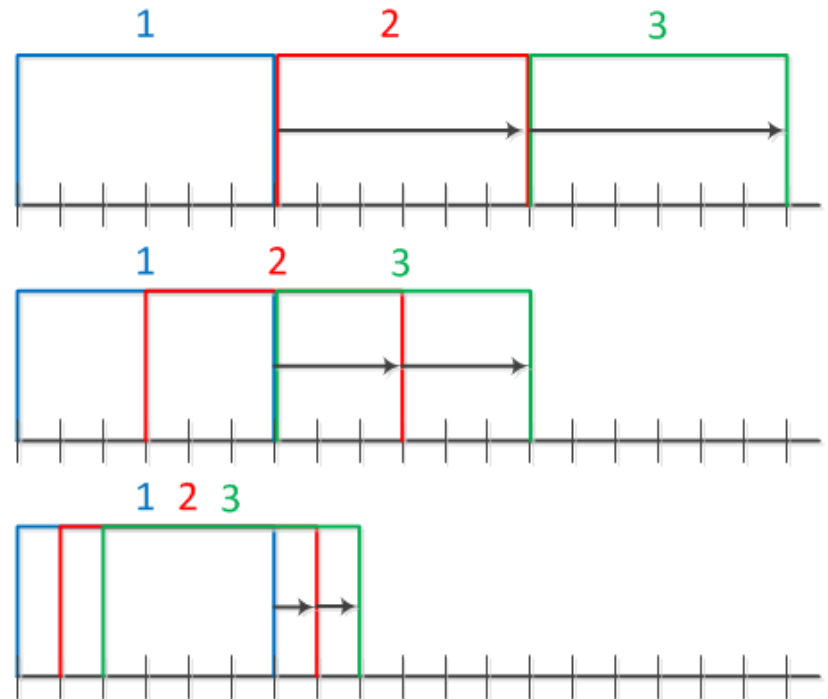

- Packet Selection Approaches (e.g. selecting fastest packets)
 - Select X% fastest packets (e.g. 2%)
 - Select N fastest packets (e.g. 10 fastest packets in a window)
 - Select all packets faster than Y (e.g. all packets faster than 150 μ s)

G.8260 Appendix I Metrics

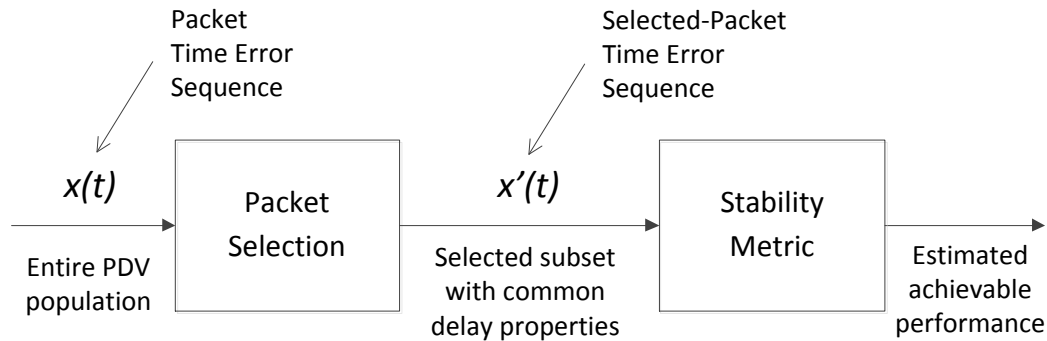

Pre-processed packet selection

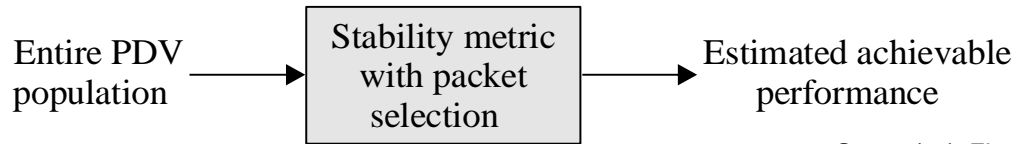

Integrated packet selection

G.8260(10)_Fl.4

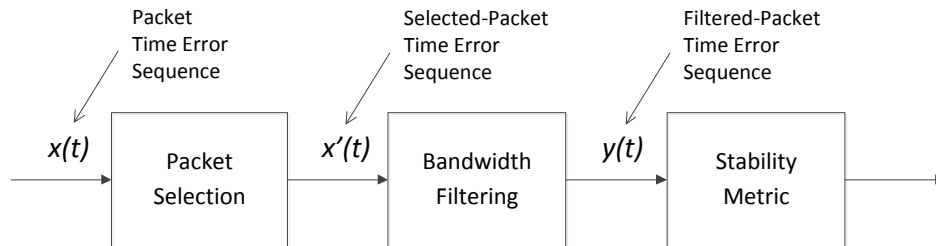

Metrics including pre-filtering

FPC, FPR, FPP: Floor Packet Count/Rate/Percent

**PDV metrics studying
minimum floor delay packet
population**

Time Transport: Two-way metrics

Packet Time Transport Metrics

Normalized roundtrip: $r(n) = \left(\frac{1}{2}\right) \cdot [R(n) + F(n)]$

Normalized offset: $\eta_2(n) = \left(\frac{1}{2}\right) \cdot [R(n) - F(n)]$

xRoundtrip: $r'(n') = \left(\frac{1}{2}\right) \cdot [R'(n') + F'(n')]$

xOffset: $\eta_2'(n') = \left(\frac{1}{2}\right) \cdot [R'(n') - F'(n')]$

minOffset: $\eta_2^m(n) = \left(\frac{1}{2}\right) \cdot [R^m(n) - F^m(n)]$

pctOffset: $\eta_2^p(n) = \left(\frac{1}{2}\right) \cdot [R^p(n) - F^p(n)]$

clusterOffset: $\eta_2^c(n) = \left(\frac{1}{2}\right) \cdot [R^c(n) - F^c(n)]$

Ideal F/R: floor

Ideal offset: zero

xTDISP (min/pct/clst time dispersion): xOffset {y} plotted against xRoundtrip {x} as a scatter plot

xOffset statistics: xOffset statistic such as mean, standard deviation, median, 95 percentile plotted as a function of time window tau; min/maxATE

Weighted average: $w(n) = [a \cdot F(n) + (1 - a) \cdot R(n)]$ where $0 \leq a \leq 1$

Time Transport: Two-way packet delay

Forward Packet Delay Sequence

#Start: 2010/03/06 17:15:30

0.0000, 1.47E-6
 0.1000, 1.54E-6
 0.2000, 1.23E-6
 0.3000, 1.40E-6
 0.4000, 1.47E-6
 0.5000, 1.51E-6

Packet Delay Sequence Reverse

#Start: 2010/03/06 17:15:30

0.0000, 1.11E-6
 0.1000, 1.09E-6
 0.2000, 1.12E-6
 0.3000, 1.13E-6
 0.4000, 1.22E-6
 0.5000, 1.05E-6

#Start: 2010/03/06 17:15:30

0.0000, 1.47E-6, 1.11E-6
 0.1000, 1.54E-6, 1.09E-6
 0.2000, 1.23E-6, 1.12E-6
 0.3000, 1.40E-6, 1.13E-6
 0.4000, 1.47E-6, 1.22E-6
 0.5000, 1.51E-6, 1.05E-6

Two-way
Data Set

Constructing f' and r'
from f and r with a 3-
sample time window

Time(s)	$f(\mu s)$	$r(\mu s)$	$f'(\mu s)$	$r'(\mu s)$
0.0	1.47	1.11		
0.1	1.54	1.09	1.23	1.09
0.2	1.23	1.12		
0.3	1.40	1.13		
0.4	1.47	1.22	1.40	1.05
0.5	1.51	1.05		

Minimum Search
Sequence

minOffset

$$\eta_2'(n') = \left(\frac{1}{2}\right) \cdot [R'(n') - F'(n')]$$

0.1	-0.07
0.4	-0.18

Time Transport: Two-way metrics

Forward/Reverse FPP

Symmetricom TimeMonitor Analyzer
Floor Packet Percent: Window=200 s; Range=50.0 us; Floor=-54.3 us; Fmin; T=200 s; A=3200; N=382
1 (blue): Fwd FPP; 2 (red): Rev FPP

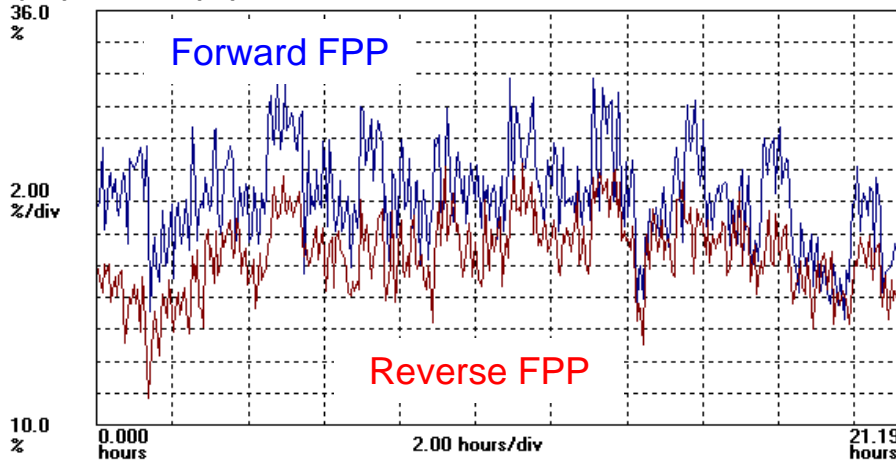

Comments:

- (1) Knowledge of asymmetry and latency in both directions is critical
- (2) Offset is a fundamental two-way calculation
- (3) Ideal fwd/rev packet: floor
Ideal offset: zero

Approaches:

- (1) Based on both one-way sequences
- (2) Based on a single sequence constructed from both one-way sequences (e.g. offset)

Two-way MAFE (MAFE of minOffset)

Symmetricom TimeMonitor Analyzer (file=probe-2008_09_04-12_54d.tpk)
MAFE; Fo=10.00 MHz; Fs=100.6 MHz; 2008/09/04; 16:55:05

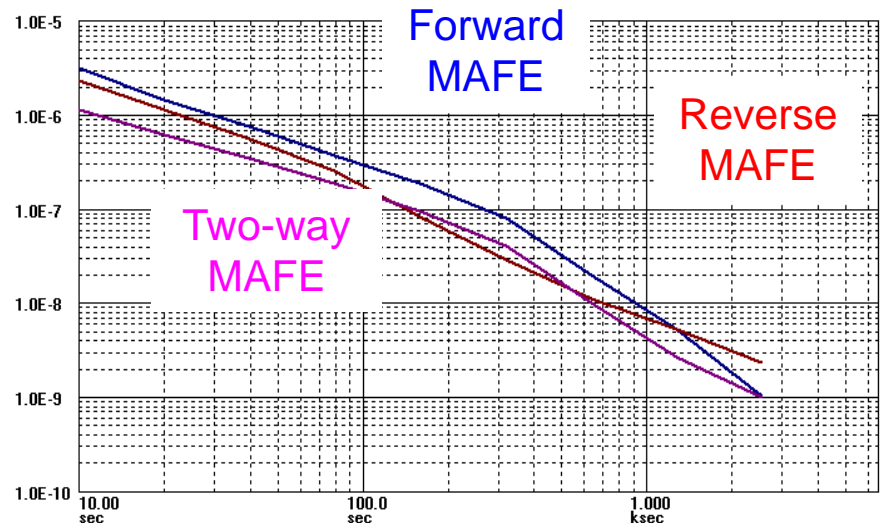

Offset ↔ Network Asymmetry

Asymmetry in Wireless Backhaul

(Ethernet wireless backhaul asymmetry and IEEE 1588 slave 1PPS under these asymmetrical network conditions)

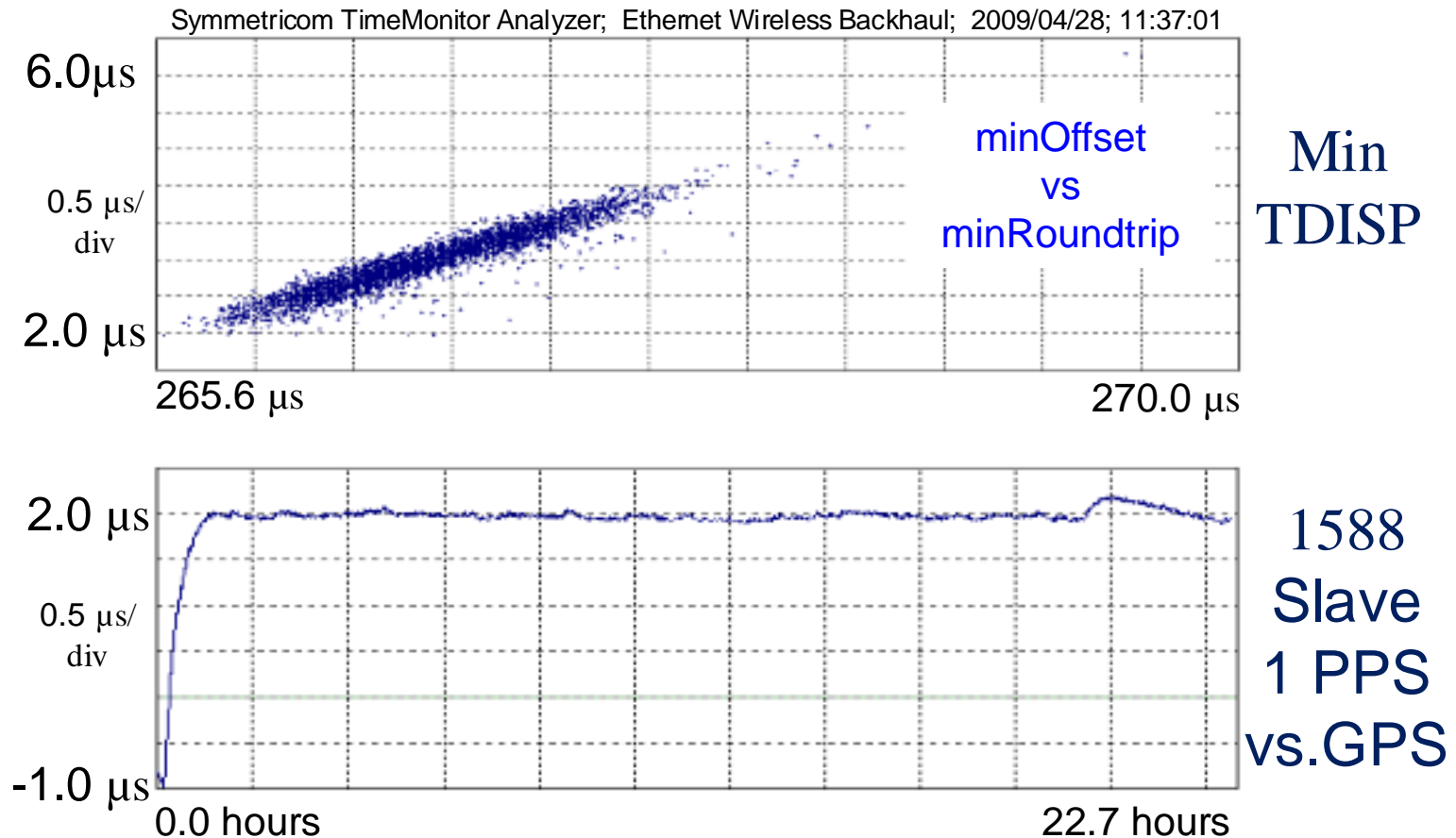

Network Asymmetry

150 km fiber SONET transport

(Offset is 20.4 μsec which represents the 40.8 μsec difference between forward and reverse one-way latencies)

Symmetricon TimeMonitor Analyzer (file=OC192_baseline_8Hz_5d-2014_04_17--20_51e.twy)
Phase deviation in units of time; Fs=7.990 Hz; Fo=10.000000 MHz; 2014/04/17 20:52:41
Two-Way Normalized Offset Phase; Samples: 799017; Initial phase offset: 20.3640 usec
OC192 Baseline Measurement; MasterUUID: 00B0AEFFFE029249; MasterIP: 10.0.1.11; ProbeUU

21.0
usec

100
nsec/div

20.0
usec

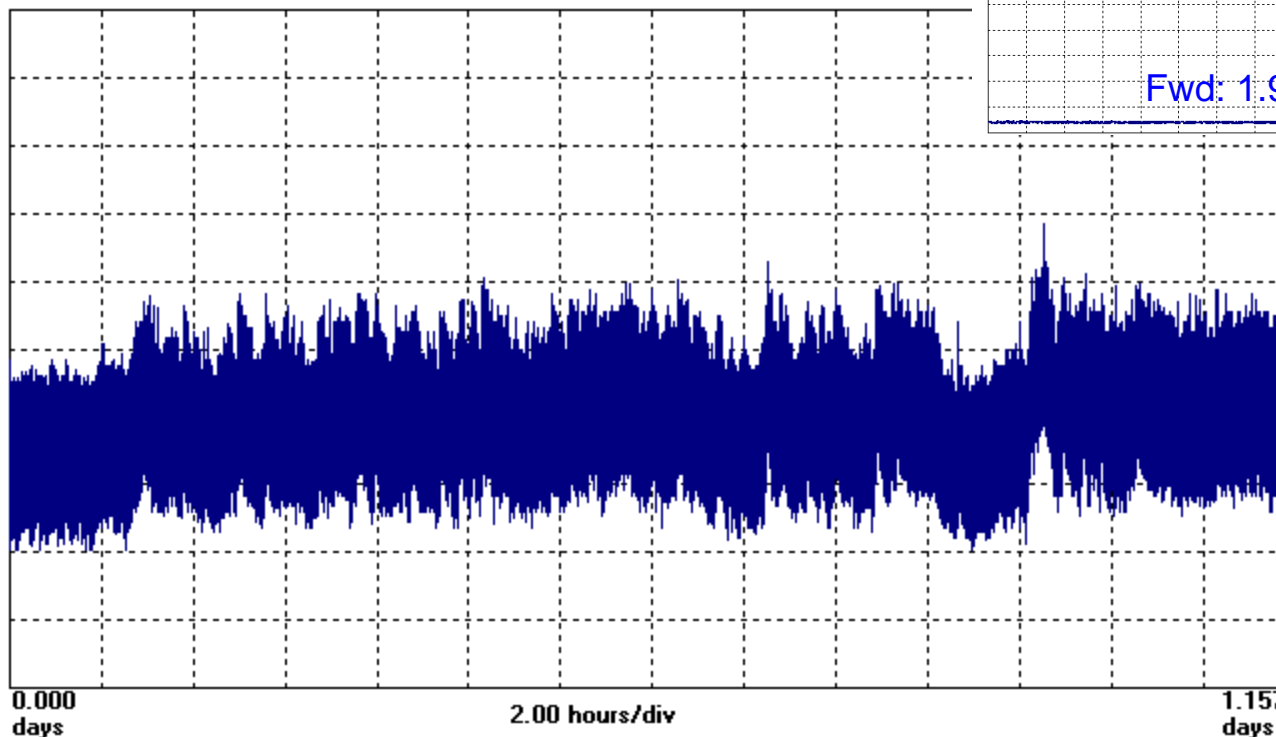

Rev: 2.014 ms

Fwd: 1.974 ms

Conclusions

- Packet time transport measurements require common time scale reference at both ends of the network being studied (GNSS at both ends is a way to do this)
- Asymmetry is everywhere, asymmetry is invisible to the IEEE 1588 protocol, thus asymmetry has a direct bearing on the ability to transport time precisely
- The “offset” calculation is a direct measure of asymmetry
- There are two ways to assess time transport: (1) measuring a 1PPS reference at the node being studied and (2) measuring a packet signal at the node being studied
- Packet metrics for time transport must use both forward and reverse streams together rather than separately as is the case for frequency transport
- Packet metrics for time transport can make use of much of the methodology used for packet frequency transport metrics

Thank You

Lee Cosart

Senior Technologist

Lee.Cosart@microsemi.com

Phone: +1-408-428-6950